

# ARTESYN DS1600SPE-3 SERIES

## 1600 Watts Distributed Power System



### PRODUCT DESCRIPTION

Advanced Energy's Artesyn DS1600SPE-3 is an ultra-high density power supply providing 40W per cubic in. The 1600 watts DS1600SPE power supply is housed in 1U high rack-mounting enclosures measuring just 3.4 x 7.7 in (86.3 x 196.5 mm). This form factor is significantly shorter than that of similarly rated earlier-generation power supplies — freeing up valuable system space — and is achieved by use of the latest power switching technology and high density component packaging techniques.

### SPECIAL FEATURES

- 1600W output power
- 1U power supply
- High power and short form factor
- Active power factor correction
- High-density design: 40W/in<sup>3</sup>
- EN61000-3-2 harmonic compliance
- Inrush current control
- 80PLUS® Platinum efficiency
- N+N, N+1 redundant
- Hot-pluggable
- Active current sharing (10 - 100% load)
- Two-year warranty
- Compatible with Artesyn's Universal PMBus™ GUI
- Reverse airflow option
- Class A + 6dB margin Conducted/Radiated EMI
- RoHS

### SAFETY

- UL/cUL 62368-1 (UL Recognized)
- Demko+CB Report EN 60950
- EN 62368-1
- CE Mark
- China CQC
- BSMI
- UKCA Mark

### TYPICAL APPLICATIONS

- Industrial

### AT A GLANCE

#### Total Power

800 to 1600 Watts

#### Input Voltage

90 to 140 Vac  
180 to 264 Vac

#### # of Outputs

Main and Standby



## MODEL NUMBERS

Standard	Output Voltage	Minimum Load	Maximum Load	Stand-By Supply	Air Flow Direction
DS1600SPE-3	12.0Vdc	0A	133.3A	12V@3.5A	Forward (DC Connector to Handle)
DS1600SPE-3-001	12.0Vdc	0A	133.3A	12V@3.5A	Reverse (Handle to DC Connector)

### Options

None

## ELECTRICAL SPECIFICATIONS

### Absolute Maximum Ratings

Stress in excess of those listed in the “Absolute Maximum Ratings” may cause permanent damage to the power supply. These are stress ratings only and functional operation of the unit is not implied at these or any other conditions above those given in the operational sections of this TRN. Exposure to any absolute maximum rated condition for extended periods may adversely affect the power supply’s reliability.

Table 1. Absolute Maximum Ratings						
Parameter	Models	Symbol	Min	Typ	Max	Unit
Input Voltage AC continuous operation	All models	$V_{IN,AC}$	90 180	- -	140 264	Vac Vac
Maximum Output Power (Main + Standby) $90 \leq V_{AC} \leq 140Vac$ $180 \leq V_{AC} \leq 264Vac$	All models	$P_{O,max}$	- -	- -	800 1600	W W
Isolation Voltage Input to outputs Input to safety ground	All models All models		- -	- -	3000 2113	Vac Vac
Ambient Operating Temperature <sup>1</sup>	All models	$T_A$	0	-	50	°C
Storage Temperature	All models	$T_{STG}$	-40	-	70	°C
Humidity (non-condensing) Operating Non-operating	All models All models		20 10	- -	95 95	% %
Altitude <sup>2</sup> Operating Non-operating	All models All models		- -	- -	16400 50000	Feet Feet

Note 1 - DS1600SPE-3: 1600W from 0 to 50°C, can operate up to 65°C at 2% derated power for every °C above 50°C.

DS1600SPE-3-001: 1600W from 0 to 40°C, can operate up to 60°C at 1% derated power for every °C above 40°C.

Note 2 - Operating altitude up to 16400 feet, derated after 10000 feet, detail see page 23.

## ELECTRICAL SPECIFICATIONS

## Input Specifications

Table 2. Input Specifications						
Parameter	Condition	Symbol	Min	Typ	Max	Unit
Operating Input Voltage, AC	All	$V_{IN,AC}$	90	115/230	264	Vac
Input AC Frequency	All	$f_{IN,AC}$	47	50/60	63	Hz
Maximum Input Current ( $I_O = I_{O,max}$ , $I_{SB} = I_{SB,max}$ )	$V_{IN,AC} = 90Vac$	$I_{IN,max}$	-	-	10.5	A
Standby Input Current ( $V_O = Off$ , $I_{SB} = 0A$ )	$V_{IN,AC} = 90Vac$	$I_{IN,Standby}$	-	-	200	mA
Standby Input Power ( $V_O = Off$ , $I_{SB} = 0A$ )	All	$P_{IN,Standby}$	-	-	7	W
No Load Input Current ( $V_O = On$ , $I_O = 0A$ , $I_{SB} = 0A$ )	$V_{IN,AC} = 90Vac$	$I_{IN,no-load}$	-	-	300	mA
Harmonic Line Currents	All	THD	Per IEC61000-3-2			
Power Factor	20% load and above	PF	-	0.90	-	
Startup Surge Current (Inrush) @ 25°C	$V_{IN,AC} = 264Vac$	$I_{IN,surge}$	-	-	55	A
Input Fuse	Internal, 5x20mm, Quick Acting 16A, 250Vdc		-	-	16	A
Leakage Current to Earth Ground	$V_{IN,AC} = 240Vac$ $f_{IN,AC} = 50/60Hz$		-	-	1.75	mA
Operating Efficiency	$V_{IN,AC} = 230Vac$ $I_O = 10\%I_{O,max}$ $I_O = 20\%I_{O,max}$ $I_O = 50\%I_{O,max}$ $I_O = 100\%I_{O,max}$	$\eta$	89	-	-	%
			93	-	-	%
			94	-	-	%
			91.5	-	-	%
Efficiency measurements done as per generalized test protocol for calculating energy efficiency of internal AC-DC and DC-DC power supplies						
AC Line Transient Deviation and Response	$V_{IN,AC} = +/-10\%$ surge or sag	$\pm\%V_O$	-1	-	+1	%
	$V_{IN,AC} = -40\%$ sag or greater for more than 25mS	Power supply restart automatically after AC input recovery				

## ELECTRICAL SPECIFICATIONS

## Output Specifications

Table 3. Output Specifications						
Parameter	Condition	Symbol	Min	Typ	Max	Unit
Factory Set Voltage	All	$\pm\%V_O$	-0.2	-	+0.2	%
		$\pm\%V_{SB}$	-3	-	+3	
Output Regulation	Inclusive of set-point, temperature change, warm-up drift and dynamic load	$V_O$	11.40	12.20	12.60	V
		$V_{SB}$	11.40	12.00	12.60	
Output Ripple, pk-pk	Measure with a 0.1 $\mu$ F ceramic capacitor in parallel with a 10 $\mu$ F tantalum capacitor, 10 to 20MHz bandwidth	$V_O$	-	-	150	mV <sub>PK-PK</sub>
		$V_{SB}$	-	-	150	
Output Current <sup>1</sup>	$90 \leq V_{AC} \leq 140V_{ac}$ $180 \leq V_{AC} \leq 264V_{ac}$	$I_O$	2 2	- -	66.67 133.3	A
	All	$I_{SB}$	0.1	-	3.5	
Main Output Current Share Accuracy	10% to 100% $I_{O,max}$		-6.67	-	6.67	A
Minimum Load for Current Sharing			10	-	-	% $I_{O,max}$
Number of Parallel Units	Main output current share connected		-	-	4	
Load Capacitance	Start up	$C_O$	2250	-	14000	$\mu$ F
		$C_{SB}$	47	-	1000	
Main Output Dynamic Response Peak Deviation		$\pm\%V_O$	-	-	5	%
Main Output Long Term Stability (Max change over 24 hours)	After thermal equilibrium (30mins)	$\pm\%V_O$	-	-	0.2	%
MTBF	Telcordia issue 2 method 1, case 3 at full load, 25°C		2	-	-	10 <sup>5</sup> h

Note 1 - Minimum current for transient load response testing only (25% step load at 0.5A/ $\mu$ S and 2250 $\mu$ F capacitance typically). Unit is designed to operate and be within output regulation range at zero load.

Note 2 - Maximum step load is 67A ( at 0.5A/ $\mu$ S and 3350 $\mu$ F capacitance typically). It requires a minimum current of 8A.

## ELECTRICAL SPECIFICATIONS

### System Timing Specifications

Table 4. System Timing Specifications					
Label	Parameter	Min	Typ	Max	Unit
T1	Delay from AC being applied to $V_{SB}$ being within regulation	20	-	2000	mSec
T2	Delay from AC being applied to main output voltages being within regulation	-	-	2300	mSec
T3	Delay from standby output to ACOK assertion	-	-	20	mSec
T4	Delay from output voltages within regulation limits to PWR_Good asserted	100	-	1000	mSec
T5	Delay from loss of AC to deassertion of PWR_Good	10	-	-	mSec
T6	Delay from de-assertion of PWR_Good to output voltages falling out of regulation	1	-	-	mSec
T7	Delay from loss of AC to main output being within regulation	11	-	-	mSec
T8	Delay from loss of AC to assertion of ACOK	-	-	7	mSec
T9	Delay from standby output to main output voltage being within regulation	-	-	300	mSec
T10	Delay from PS_ON_L assertion to output voltages being within regulation	-	-	350	mSec
T11	Delay from loss of AC to standby output being within regulation	150	-	-	mSec
T12	Output voltage rise time from the main output	2	-	60	mSec
T13	Output voltage rise time from the standby output	2	-	60	mSec

# ELECTRICAL SPECIFICATIONS

System Timing Diagram

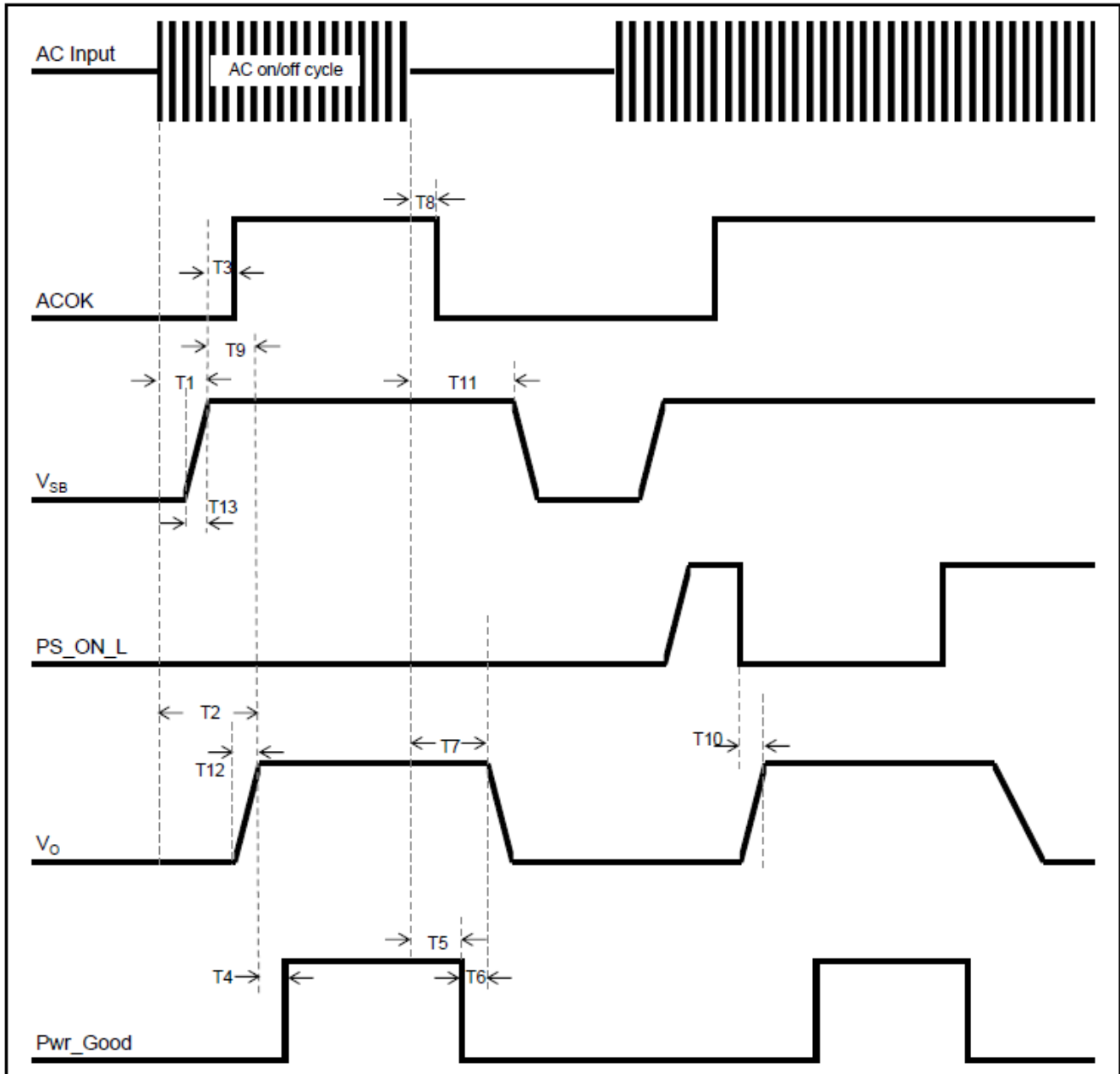

ELECTRICAL SPECIFICATIONS

DS1600SPE-3 Performance Curves

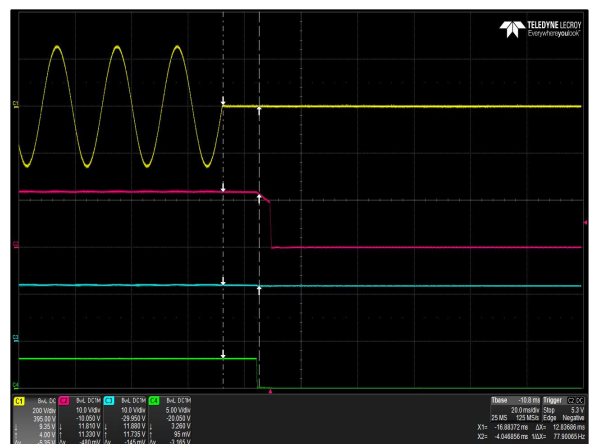
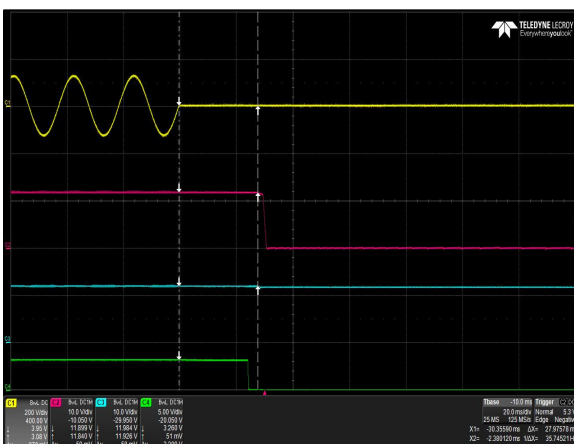
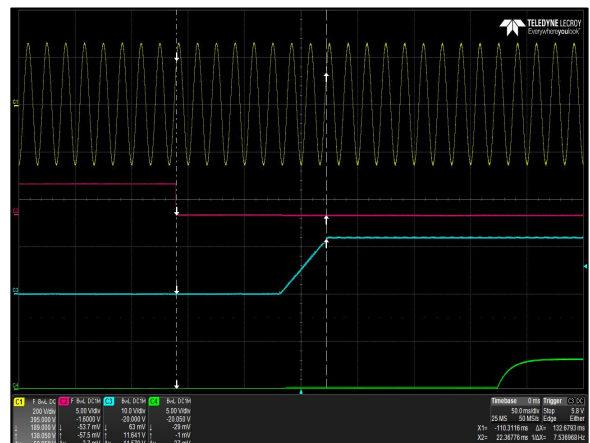
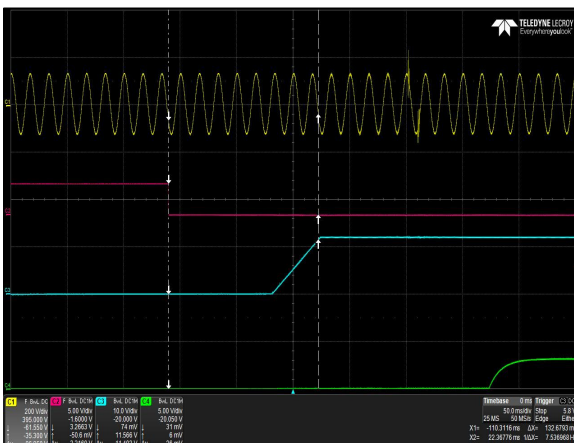
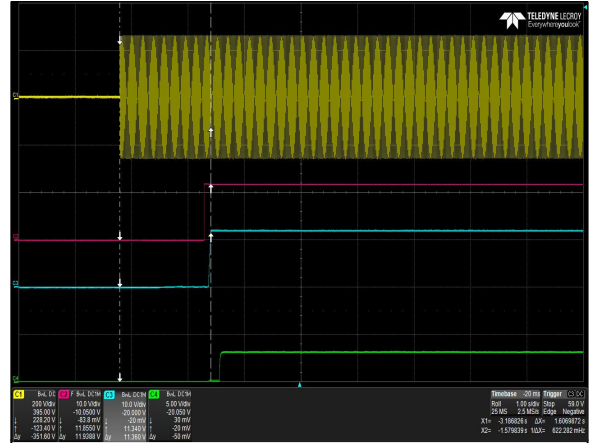
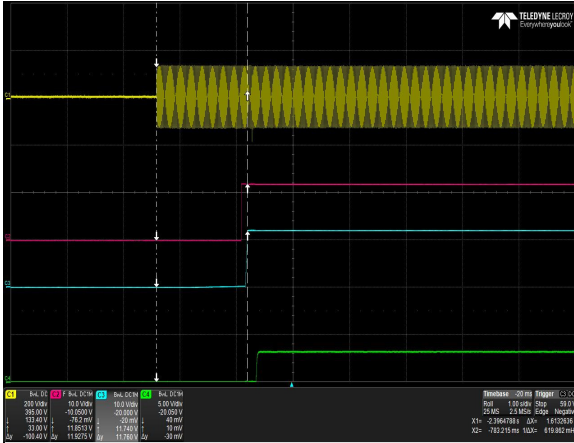



# ELECTRICAL SPECIFICATIONS

## DS1600SPE-3 Performance Curves

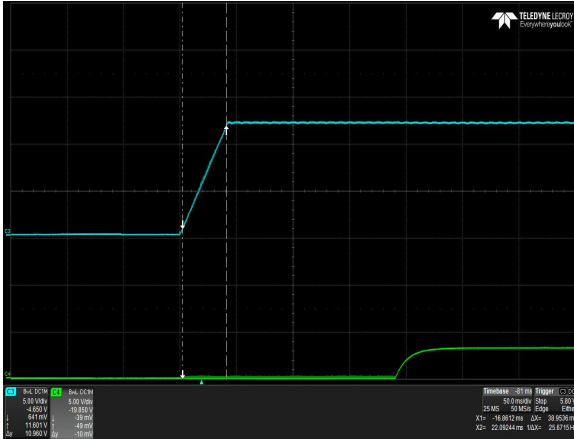

Figure 7: DS1600SPE-3 Output Voltage Startup Characteristic  
 Vin = 90Vac Load:  $I_O = 63.2A$   $I_{SB} = 3.5A$   
 Ch 3:  $V_O$  Ch 4: Pwr\_GOOD



Figure 8: DS1600SPE-3 Output Voltage Startup Characteristic  
 Vin = 180Vac Load:  $I_O = 129.8A$   $I_{SB} = 3.5A$   
 Ch 3:  $V_O$  Ch 4: Pwr\_GOOD

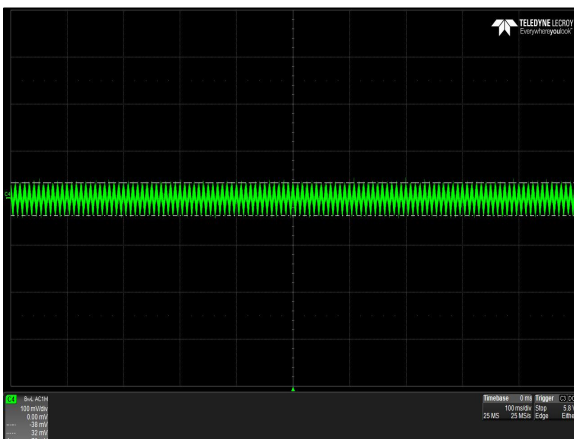

Figure 9: DS1600SPE-3 Ripple and Noise Measurement  
 Vin = 90Vac Load:  $I_O = 63.2A$   $I_{SB} = 3.5A$   
 Ch 4:  $V_O$

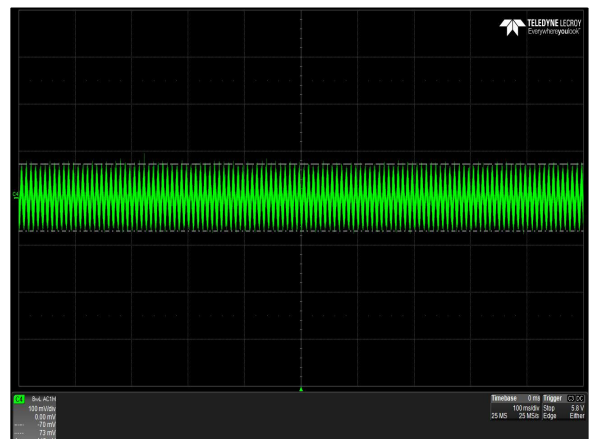

Figure 10: DS1600SPE-3 Ripple and Noise Measurement  
 Vin = 180Vac Load:  $I_O = 129.8A$   $I_{SB} = 3.5A$   
 Ch 4:  $V_O$

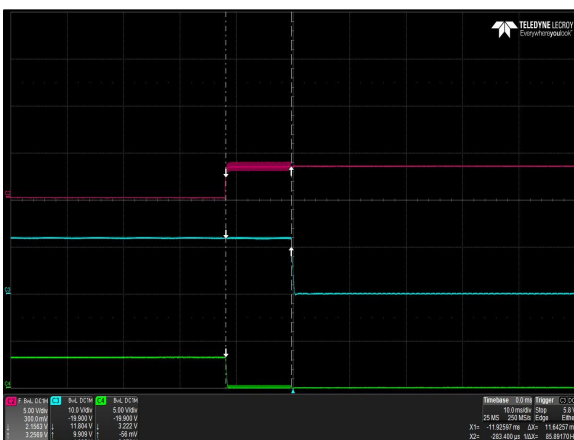

Figure 11: DS1600SPE-3 Turn Off Characteristic via PS\_ON\_L  
 Load:  $I_O = 129.8A$   $I_{SB} = 3.5A$   
 Ch 2: PS\_ON\_L Ch 3:  $V_O$  Ch 4: Pwr\_GOOD

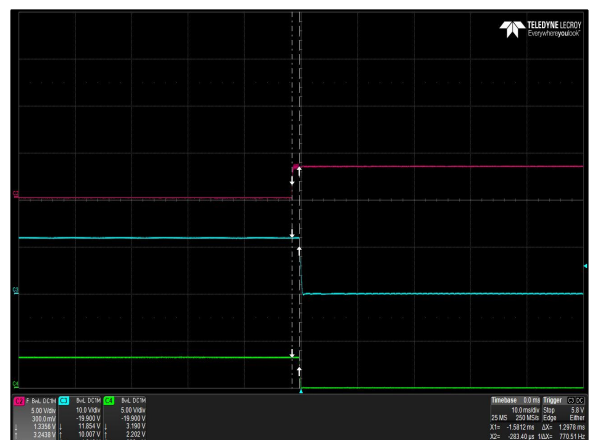

Figure 12: DS1600SPE-3 Turn Off Characteristic via PS\_KILL\_L  
 Load:  $I_O = 129.8A$   $I_{SB} = 3.5A$   
 Ch 2: PS\_KILL\_L Ch 3:  $V_O$  Ch 4: Pwr\_GOOD

# ELECTRICAL SPECIFICATIONS

## DS1600SPE-3 Performance Curves

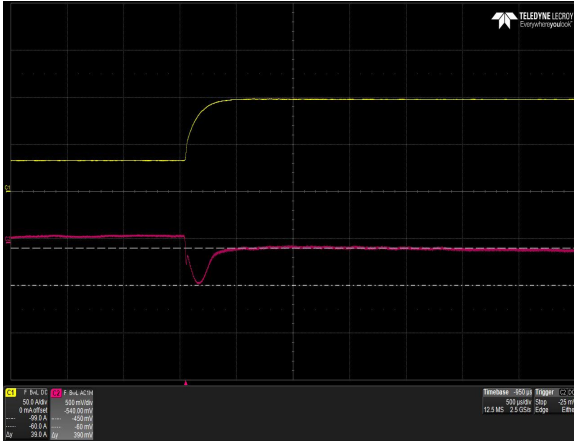

Figure 13: DS1600SPE-3 Transient Response -  $V_O$  Deviation  
 25% to 75% load change 1A/uS slew rate  $V_{in} = 230V_{ac}$   
 Ch 1:  $I_o$  Ch 2:  $V_O$  Output capacitance=2350uF

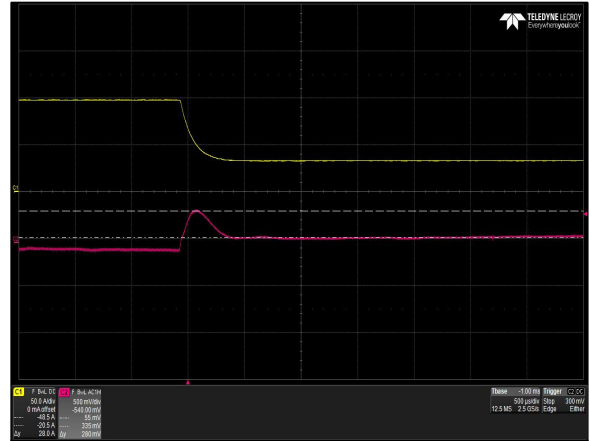

Figure 14: DS1600SPE-3 Transient Response -  $V_O$  Deviation  
 75% to 25% load change 1A/uS slew rate  $V_{in} = 230V_{ac}$   
 Ch 1:  $I_o$  Ch 2:  $V_O$  Output capacitance=2350uF

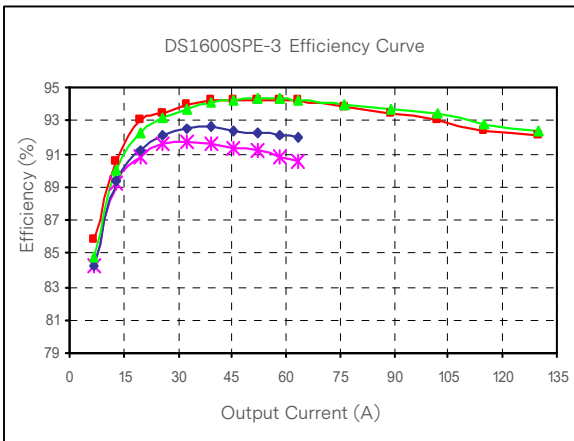

Figure 15: DS1600SPE-3 Efficiency Curve @ 25°C  
 Loading:  $I_{o\_main} = 10\%I_{o\_max}$  increment to 129.8A,  $I_{SB} = 3.5A$

## ELECTRICAL SPECIFICATIONS

### Protection Function Specifications

#### Input Fuse

DS1600SPE-3 series power supply is equipped with an internal non user serviceable 16A Fast Acting 250Vac fuse to IEC 127 for fault protection on L line input.

#### Over Voltage / Under Voltage Protection (OVP / UVP)

The power supply provides latch mode over and under voltage protection as defined by the output under voltage and output over voltage parameters for each output. A fault on the main output and standby will not cause the standby output to shutdown.

##### OVP

Parameter	Min	Nom	Max	Unit
V <sub>O</sub> Output Overvoltage	13.5	/	15.0	V
V <sub>SB</sub> Output Overvoltage	13.5	/	15.0	V

##### UVP

Parameter	Min	Nom	Max	Unit
V <sub>O</sub> Output Under-voltage	10.5	/	11.0	V
V <sub>SB</sub> Output Under-voltage	10.0	/	11.0	V

#### Over Current Protection (OCP)

DS1600SPE-3 series includes internal current limit circuitry to prevent damage in the event of overload or short circuit. Recovery must be automatic when the overload is removed, if the overload lasts for 500 milliseconds or less, and if it is less than or equal to 115% of rated load. If the overload is >125% of rated load, the power supply will latch off immediately within 10ms. The latched state will require AC power / PS\_ON\_L recycling or OFF-ON recycling via the PMBus 01h OPERATION command to restart the power supply. A fault in the main output will not cause the standby output to shut down. No damage will result to the supply as the result of either short term or long term overloads of the outputs.

The standby output have an OCP limit from 120% to 150% and will auto-recover when the overload is removed. A fault in the standby output will shutdown other outputs and will auto-recover as well when the overload on the standby is removed.

Parameter	Min	Nom	Max	Unit
V <sub>O</sub> Output Overvoltage	115	/	150	%I <sub>O</sub>
V <sub>SB</sub> Output Overvoltage	120	/	150	%I <sub>O</sub>

## ELECTRICAL SPECIFICATIONS

### Short Circuit Protection (SCP)

The DS1600SPE-3 power supply will withstand a continuous short circuit with no permanent damage, applied to its main output during start-up or while running. A short circuit is defined as an impedance on  $V_o$  of 0.04ohms or less.

When the standby output is shorted the output will go into “hiccup mode”. When the standby output attempts to restart, the maximum peak current from the standby output will be less than 20.0A peak. The maximum average current, taking into account the “hiccup” duty cycle, is less than rated output current.

Excessive peak currents due to the discharge of output capacitors are not controllable in the event of short circuit at the output.

### Over Temperature Protection (OTP)

The power supply will be internally protected against over temperature conditions. There will be three over-temperature protection sensings - on the main output, the PFC circuit and on the standby output. When one of the sensing circuits has reached the OTP limit, all outputs, except standby, will shut down and will remain off until the over-temperature condition no longer exists. The standby output will shut down due to OTP only when the ambient temp has gone above 80degC. A suitable hysteresis point between the OTP threshold and the recovery point will be set to ensure there is no frequent on-off cycling of the outputs. The temperature recovery point will be set well within the operating temperature range. Upon reaching the temperature recovery point, all outputs will auto-recover.

Any OTP fault will be reported in the PMBus status flag, without discriminating on which OTP sensing circuit was triggered.

### Input Brown-out Protection

Dual rating of the power supply for input line should be considered during brown-out tests. When brown-out tests are done at high line input, the power supply will protect itself from drawing excessive power from the input line when the input voltage is less than 180Vac, and when the load is greater than 800W. The over-current limit threshold will revert to the low line limit as soon as the power supply senses that the input line is less than 180Vac. In the event that the load is greater than 800W and the input has fallen below 180Vac, the power supply will enter into the over-current protection state. This state can only be cleared by recycling AC power or toggling PS\_ON, or issuing an OFF command via PMBus.

The power supply automatically determines low line or high line operating modes during initial power-up. It is not expected for the input line to change between low line and high line ratings once the power supply is installed in a site. Any continuous input below 160Vac shall be considered as low line, and any continuous voltage above 170Vac shall be considered as high line.

It is recommended for the system to determine the input voltage of the power supply to manage the load, thereby, prevent an over-current condition.

90 to 140Vac, 800W maximum output power. At low line input range, the power supply must turn-on below 90Vac and must turn-off above 80Vac. Sufficient hysteresis must be provided to avoid toggling.

180 to 264Vac, 1600W maximum output power. At high line input range, the power supply must turn-on below 180Vac and must turn-off above 170Vac. Sufficient hysteresis must be provided to avoid toggling.

The standby output shall operate from 90 to 264Vac.

### Fan Fault Protection

The power supply will be internally protected against fan fault conditions. Standby mode operation can require or not require airflow to cool the power supply. If used in redundant mode operation and when the 12V main is present, fans are allowed to run even if there is no AC input on a unit. Whenever fans are running, the system should be allowed over-ride control of the fan. Standby output will shut down during fan is latch/killed.

# MECHANICAL SPECIFICATIONS

**Mechanical Outlines** (unit:mm)

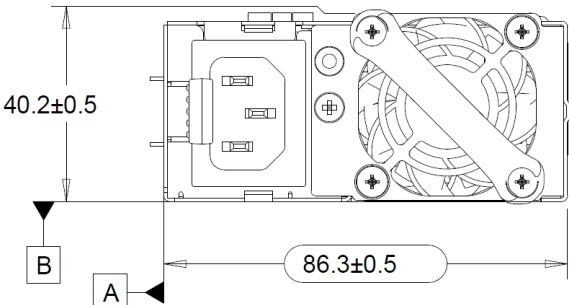
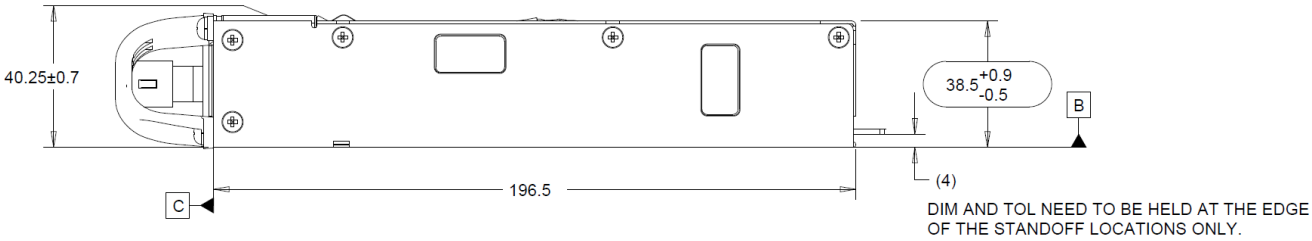
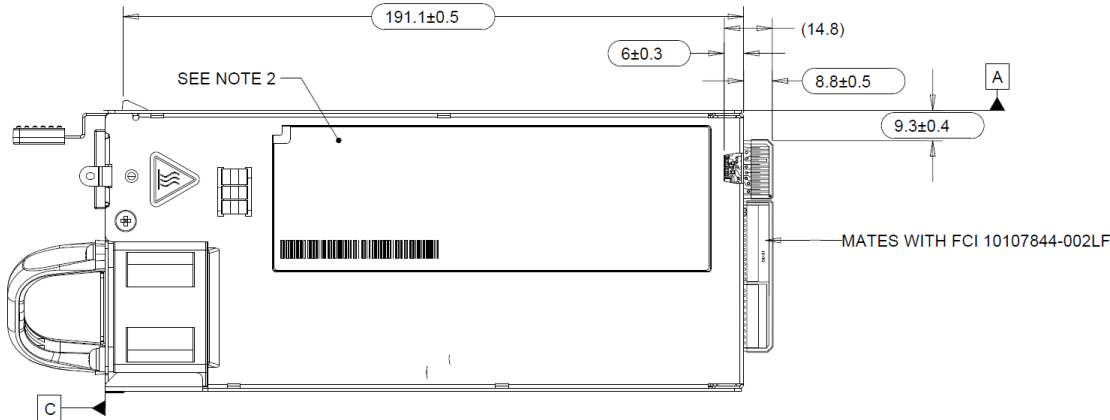

MODEL	AIRFLOW DIRECTION
DS1600SPE-3	FORWARD
DS1600SPE-3-001	REVERSE
DS1600SPE-3-401	FORWARD

# MECHANICAL SPECIFICATIONS

## Connector Definitions

AC Input Connector

Pin 1 – L1

Pin 2 – L2

Pin 3 – Earth Ground

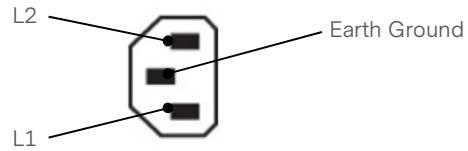

Output Connector - Power Blades

P1-P8 – Main Output ( $V_O$ )

P9-P18 – Main Output Return

P19-P20 – Standby Output ( $V_{SB}$ )

P21-P28 – Main Output Return

P29-P36 – Main Output ( $V_O$ )

Power Supply Output Card Edge (Top Side)

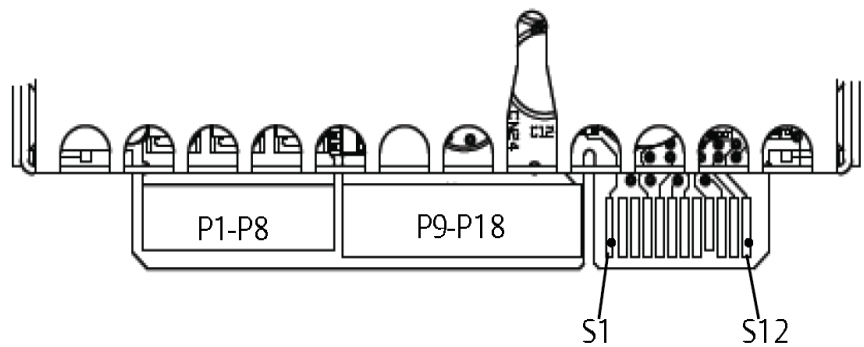

Output Connector - Control Signals

- S1 – PS\_PRESENT
- S2 – A1
- S3 – A0
- S4 – PWR\_GOOD
- S5 – ACOK (AC Input Present)
- S6 – RETURN
- S7 – ISHARE
- S8 – RESERVED
- S9 – PS\_INTERRUPT\_L
- S10 – RETURN
- S11&S12 – RESERVED
- S13 – PS\_ON\_L
- S14 – PS\_KILL\_H
- S15 – RESERVED
- S16 – RETURN
- S17 – SDA
- S18 – RETURN
- S19 – SCL
- S20 – RETURN
- S21 – REMOTE SENSE-
- S22 – RETURN
- S23 – REMOTE SENSE+
- S24 – A2

Power Supply Output Card Edge (Bottom Side)

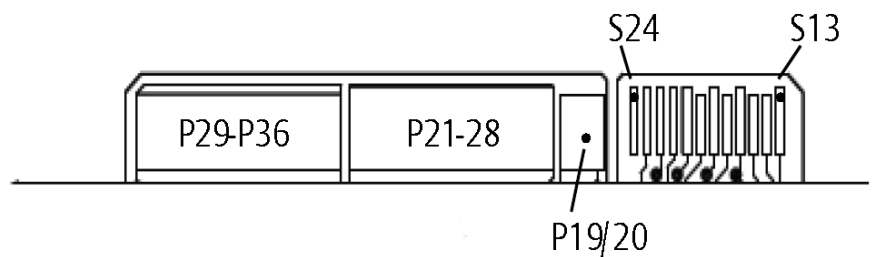

## MECHANICAL SPECIFICATIONS

### Power / Signal Mating Connectors and Pin Types

Table 5. Mating Connectors for DS1600SPE-3 Series		
Reference	On Power Supply	Mating Connector or Equivalent
AC Input Connector	IEC320-C13	IEC320-C14
Output Connector	Card-edge	FCI Power Blade 10107844-002LF Straight Pins
		FCI Power Blade 10115859-004LF Right Angle Pins

## MECHANICAL SPECIFICATIONS

### LED Indicator Definitions

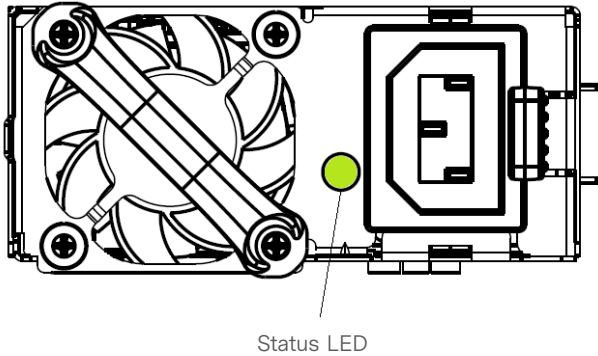

One bi-color (green/amber) LED at the power supply front provides the status signal. The status LED conditions are shown on the below table.

Conditions	LED Status
AC Input = OFF	Off
$V_{SB} = ON, V_O = ON$	Solid Green
$V_{SB} = ON, V_O = OFF, AC\ Input = ON$	Blinking Amber
$V_O/V_{SB} = OCP / OVP / OTP / FAN\ FAULT$	Blinking Amber



## MECHANICAL SPECIFICATIONS

### Weight

The DS1600SPE-3 series power supply weight is 1kg/2.2lbs maximum.

## ENVIRONMENTAL SPECIFICATIONS

### EMC Immunity

DS1600SPE-3 series power supply is designed to meet the following EMC immunity specifications.

Table 6. Environmental Specifications	
Document	Description
FCC 47 CFR 15 Subpart C / ISPR22 / B / EN55032, Class A	Conducted and Radiated EMI Limits
EN61000-3-2	Harmonic Currents
EN61000-3-3	Voltage Fluctuations
IEC/EN61000-4-2	Electromagnetic Compatibility (EMC) - Testing and measurement techniques - Electrostatic discharge immunity test: +/-15KV air, +/-8KV contact discharge. Performance - Criteria B
IEC/EN61000-4-3	Electromagnetic Compatibility (EMC) - Testing and measurement techniques - Radiated, radio-frequency, electromagnetic field immunity test: Performance - Criteria A
IEC/EN61000-4-4	Electromagnetic Compatibility (EMC) - Testing and measurement techniques - Electrical fast transient/burst immunity test: 2KV for AC power port. Performance - Criteria B 0.5KV for DC ports, I/O and signal ports. Performance - Criteria A
IEC/EN61000-4-5	Electromagnetic Compatibility (EMC) - Testing and measurement techniques - Surge test: 2KV common mode and 1KV differential mode for AC ports. Performance - Criteria B
IEC/EN61000-4-11	Electromagnetic Compatibility (EMC) - Testing and measurement techniques - Voltage dips and interruptions: Criteria C: >95% reduction for 10ms; Criteria C: >30% reduction for 500mS, or Criteria C: >95% reduction for 500mS.
EN55032	Information Technology Equipment - Immunity Characteristics, Limits and Method of Measurements

## ENVIRONMENTAL SPECIFICATIONS

### Safety Certifications

The DS1600SPE-3 series power supply is intended for inclusion in other equipment and the installer must ensure that it is in compliance with all the requirements of the end application. This product is only for inclusion by professional installers within other equipment and must not be operated as a stand alone product.

Table 7. Safety Certifications for DS1600SPE-3 Series Power Supply		
Standard	File #	Description
UL62368-1	E186249-A6038-UL-X10	US and Canada Requirements
CSA 22.2 No. 62368-1	E186249-A6038-UL-X10	Information Technology Equipment - Safety - Part 1: General Requirements (Bi-National standard, with UL 62368-1)
EN62368-1	D-07623	European Requirements
EN62368-1 Deviations	DK-89524-UL	International Requirements
CB Certificate and Report	E186249-A6038-CB-1	(All CENELEC Countries)
CHINA CQC Approval	CQC14001111984	China Requirements
BSMI	CI339161604032 A1	Taiwan Requirement
UKCA Mark		UK Requirements

# ENVIRONMENTAL SPECIFICATIONS

## EMI Emissions

The DS1600SPE-3 series power supply has been designed to comply with the Class A limits of EMI requirements of EN55032 (FCC Part 15) and CISPR 22 (EN55032) for emissions and relevant sections of EN61000 (IEC61000) for immunity. The unit is enclosed inside a metal box, tested at 1600W using resistive load with cooling fan.

### Conducted Emissions

The applicable standard for conducted emissions is EN55032 (FCC Part 15). Conducted noise can appear as both differential mode and common mode noise currents. Differential mode noise is measured between the two input lines, with the major components occurring at the supply fundamental switching frequency and its harmonics. Common mode noise, a contributor to both radiated emissions and input conducted emissions, is measured between the input lines and system ground and can be broadband in nature.

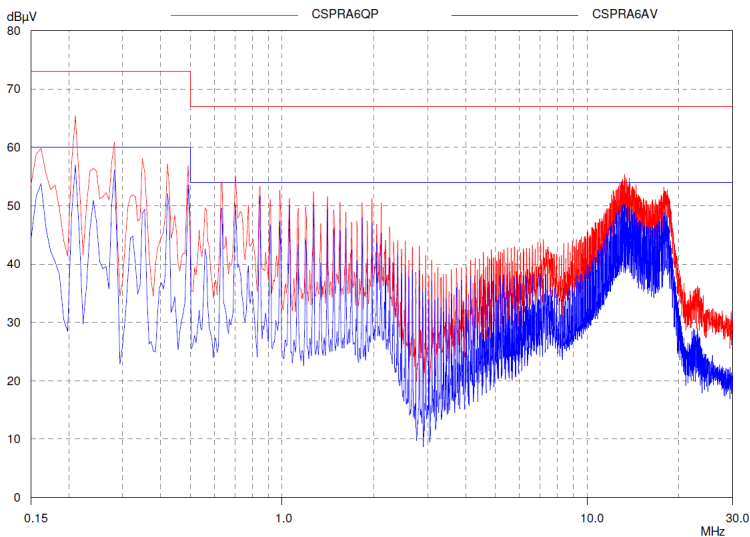

The DS1600SPE-3 series power supply has internal EMI filters to ensure the convertor's conducted EMI levels comply with EN55032 (FCC Part 15) Class A and EN55032 (CISPR 22) Class A limits. The EMI measurements are performed with resistive loads at maximum rated loading.

Sample of EN55032 Conducted EMI Measurement at 110Vac input

Note: Red Line refers to Artesyn Quasi Peak margin, which is 6dB below the CISPR international limit. Blue Line refers to the Artesyn Average margin, which is 6dB below the CISPR international limit.

**Table 8. Conducted EMI Emission Specifications of The DS1600SPE-3 Series Power Supply**

Parameter	Model	Symbol	Min	Typ	Max	Unit
FCC Part 15, class A	All	Margin	-	-	6	dB
CISPR 22 (EN55032), class A	All	Margin	-	-	6	dB

### Radiated Emissions

Unlike conducted EMI, radiated EMI performance in a system environment may differ drastically from that in a stand-alone power supply. It is thus recommended that radiated EMI be evaluated in a system environment. The applicable standard is EN55022 Class A (FCC Part 15). Testing AC-DC converters as a stand-alone component to the exact requirements of EN55022 can be difficult because the standard calls for 1m lead to be attached to the input and outputs and aligned such as to maximize the disturbance. In such a set-up, it is possible to form a perfect dipole antenna that very few AC-DC converters could pass. However, the standard also states that an attempt will be made to maximize the disturbance consistent with the typical application by varying the configuration of the test sample.

## ENVIRONMENTAL SPECIFICATIONS

### Forced Air Cooling

The DS1600SPE-3 series power supplies include internal cooling fans as part of the power supply assembly to provide forced air-cooling to maintain and control temperature of devices and ambient temperature in the power supply to appropriate levels. The standard direction of airflow is from the DC connector end to the AC connector end of the power supply.

The cooling fan is a variable speed fan. The power supply determines the fan speed required for cooling. The system may over-ride this RPM but only if it is higher than what the power supply needs to cool itself. In standby mode power supply fan will operate at minimum speed to maintain component reliability at all load, line and ambient conditions. When 12V output is enabled, power supply fan will operate at minimum achievable fan speed. Power supply fan speed control algorithms will vary the speed so that the critical component temperatures do not exceed safe operating levels. The system may also over-ride the power supply fan speed only if the system RPM is greater than the power supply calculated RPM. Fans will be powered from voltage source inside the power supply and from system side voltage source.

Standby mode operation can require or not require airflow to cool the power supply. If used in redundant mode operation and when the 12V main is present, fans are allowed to run even if there is no AC input on a unit. Whenever fans are running, the system should be allowed over-ride control of the fan.

# ENVIRONMENTAL SPECIFICATIONS

## Power Derating Curves

DS1600SPE-3 series total output power will be derated according to the curve shown below. All models can provide derated output power from 50degC up to 65degC ambient temperature max.

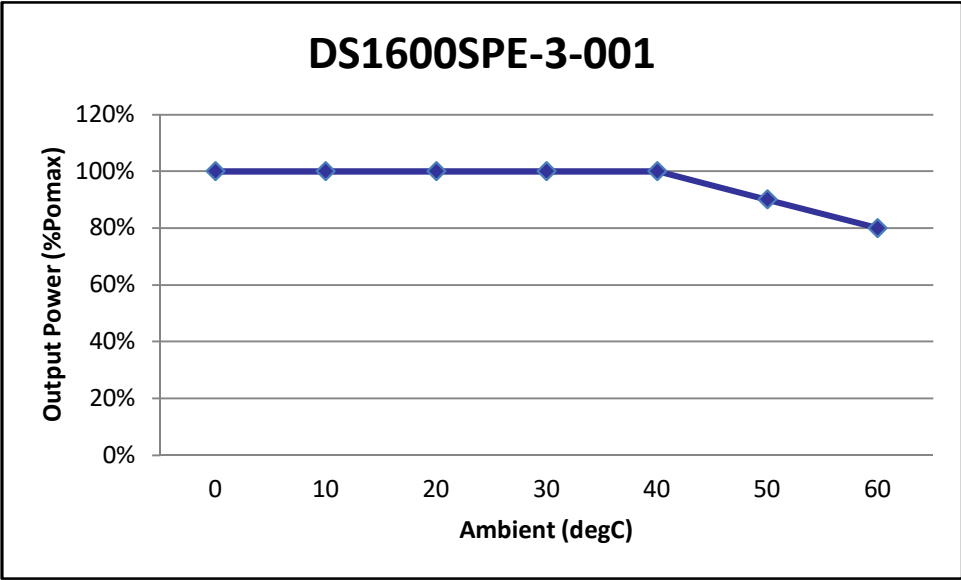
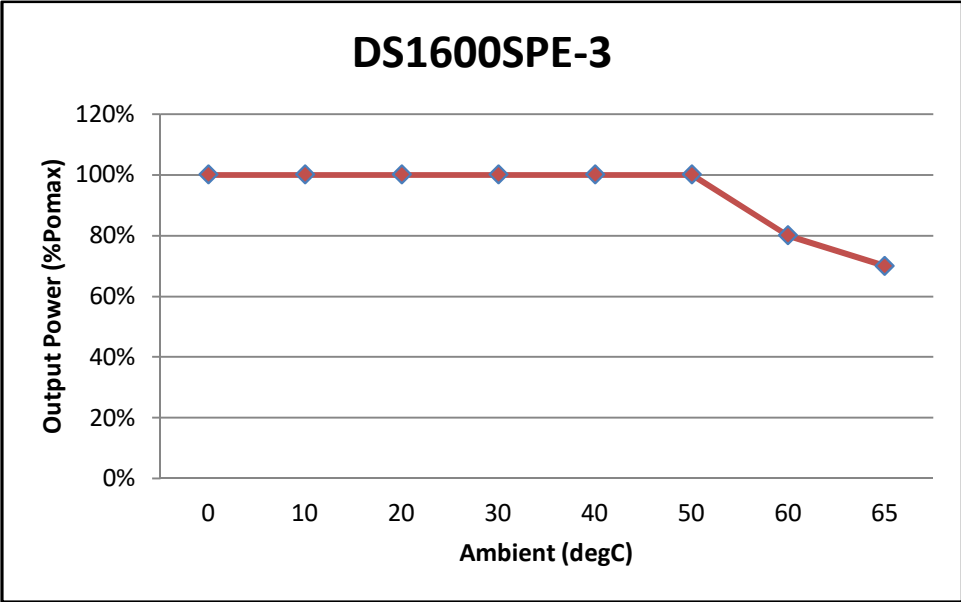

# ENVIRONMENTAL SPECIFICATIONS

## Storage and Shipping Temperature

The DS1600SPE-3 series power supply can be stored or shipped at temperatures between -40°C to +70°C and relative humidity from 10% to 95% non-condensing.

## Altitude

The DS1600SPE-3 series power supply will operate within specifications at altitudes up to 16400 feet above sea level. The power supply will not be damaged when stored at altitudes up to 50000 feet above sea level.

When Altitude come up to 16400 feet of see level, (ambient temperature derated to 40 degree C at 10000 feet), power derates to 80% load at 50°C or 100% load at 35°C.

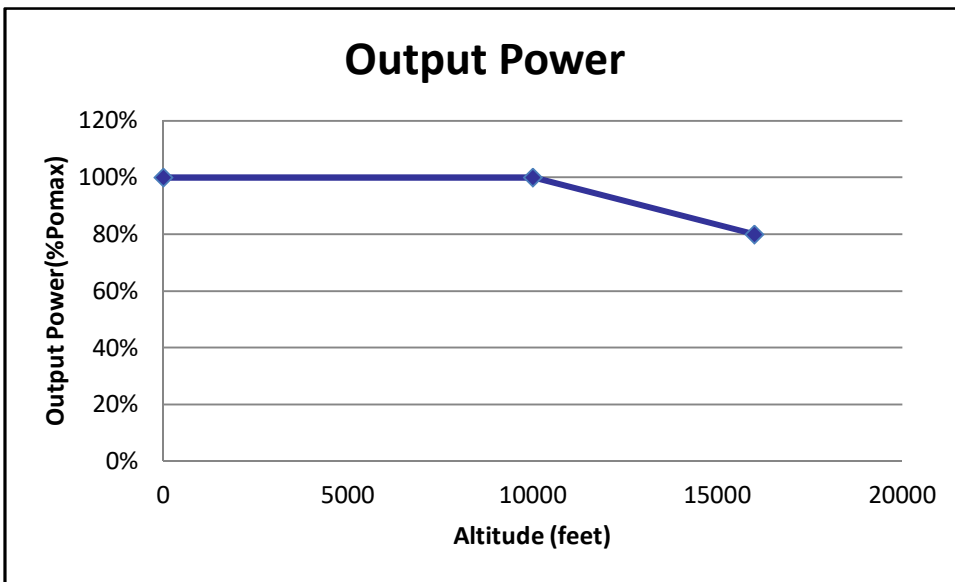

## Humidity

Operating: Power supply will be designed to operate with no degradation of performance while operating in range of 20%RH to 95%RH non-condensing.

Non-Operating: Power supply will be designed to operate with no degradation of performance while operating in range of 10%RH to 95%RH non-condensing.

## ENVIRONMENTAL SPECIFICATIONS

### Vibration

The DS1600SPE-3 series power supply will pass the following vibration specifications:

#### Non-Operating Random Vibration

Acceleration	2.21	gRMS	
Frequency Range	5 - 500	Hz	
Duration	30	Mins	
Direction	Rotating each axis on vertical vibration		
PSD Profile	FREQ (Hz)	SLOPE (db/oct)	PSD (g <sup>2</sup> /Hz)
	5	/	0.001
	20	/	0.01
	500	/	0.01

#### Operating Random Vibration

Acceleration	3.12	gRMS	
Frequency Range	5 - 500	Hz	
Duration	30	Mins	
Direction	Rotating each axis on vertical vibration		
PSD Profile	FREQ (Hz)	SLOPE (db/oct)	PSD (g <sup>2</sup> /Hz)
	5	/	0.002
	20	/	0.02
	500	/	0.02

### Shock

The DS1600SPE-3 power supply passed the following vibration specifications:

#### Non-Operating Half-Sine Shock

Acceleration	30	G
Duration	18	mSec
Pulse	Half-sine	
Number of Shock	3 shocks on each of 6 faces	



## POWER AND CONTROL SIGNAL DESCRIPTIONS

### AC Input Connector

This connector supplies the AC Mains to the DS1600SPE-3 series power supply.

- Pin 1 – L1
- Pin 2 – L2
- Pin 3 – Earth Ground

### Output Connector – Power Blades

These pins provide the main output for the DS1600SPE-3 series power supply. The main output ( $V_O$ ) and the main output return pins are the positive and negative rails, respectively, of the  $V_O$  main output of the DS1600SPE-3 series power supply.

- P1-P8 – Main Output ( $V_O$ )
- P9-P18 – Main Output Return
- P19-P20 – Standby Output ( $V_{SB}$ )
- P21-P28 – Main Output Return / Standby Output Return
- P29-P36 – Main Output ( $V_O$ )

### Output Connector – Control Signals

The DS1600SPE-3 series power supply contains a 24 pins control signal header providing an analogue control interface, standby power and I<sup>2</sup>C interface signal connections.

#### PS\_PRESENT - (Pin S1)

This signal used to indicate to the system that a power supply is inserted in the power bay. This pin is connected to the standby return via 220ohm resistor in the power supply. Recommended pull-up resistor to 12Vsb is 8.2kohm with a 3.0kohm pull-down to ground. A 100pF decoupling capacitor is also recommended.

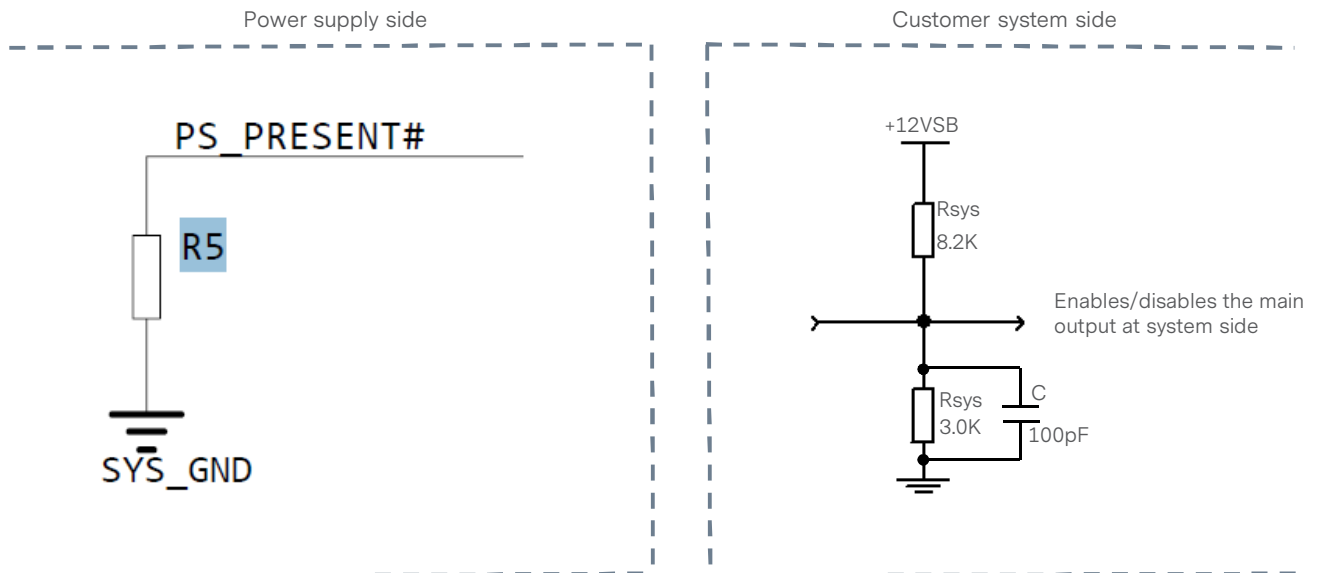

#### A0, A1 and A2 - (Pins S2, S3 and S24)

Please refer to "Communication Bus Descriptions" section.

# POWER AND CONTROL SIGNAL DESCRIPTIONS

## PWR\_GOOD - (Pin S4)

Signal used to indicate that main output voltage is within regulation range. The PWR\_GOOD signal will be driven HIGH when the output voltage is valid and will be driven LOW when the output falls below the under-voltage threshold. This signal also gives an advance warning when there is an impending power loss due to loss of AC input or system shutdown request.

This is an open collector/drain output. This pin is pulled high by a 1.0Kohm resistor connected to 3.3V inside the power supply. It is recommended that this pin is connected to a 100pF decoupling capacitor and pulled down by a 10Kohm resistor.

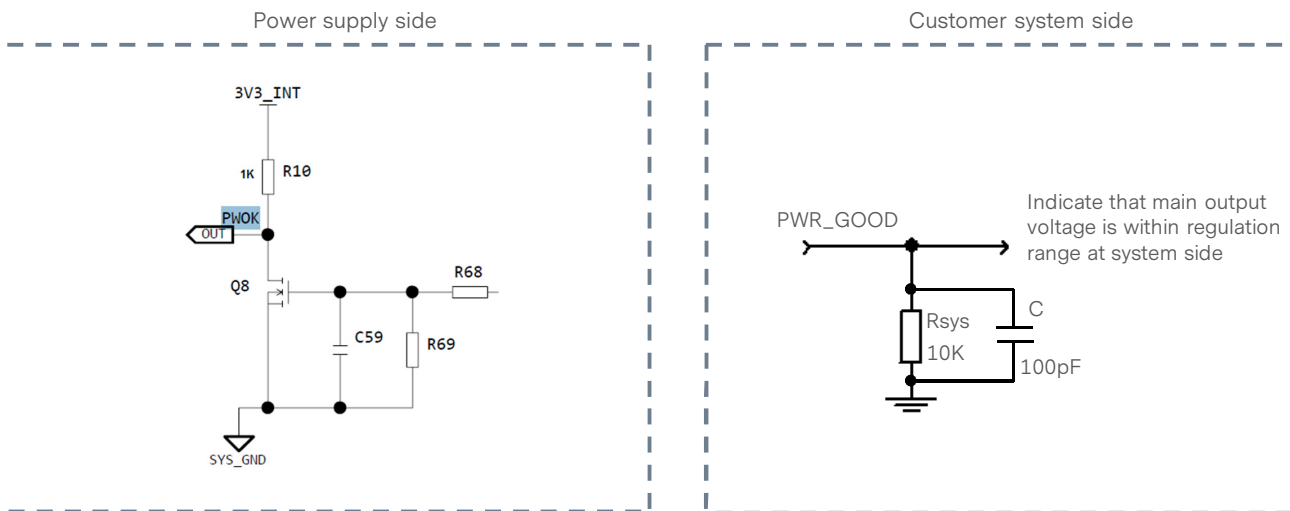

## ACOK - (Pin S5)

Signal used to indicate the presence of AC input to the power supply. A logic level HIGH will indicate that the AC input to the power supply is within the operating range while a logic level LOW will indicate that AC has been lost. This is an open collector/drain output. This pin is pulled high by a 1.0Kohm resistor connected to 3.3V inside the power supply. It is recommended that this pin be connected to a 100pF decoupling capacitor and pulled down by a 100K ohm resistor.

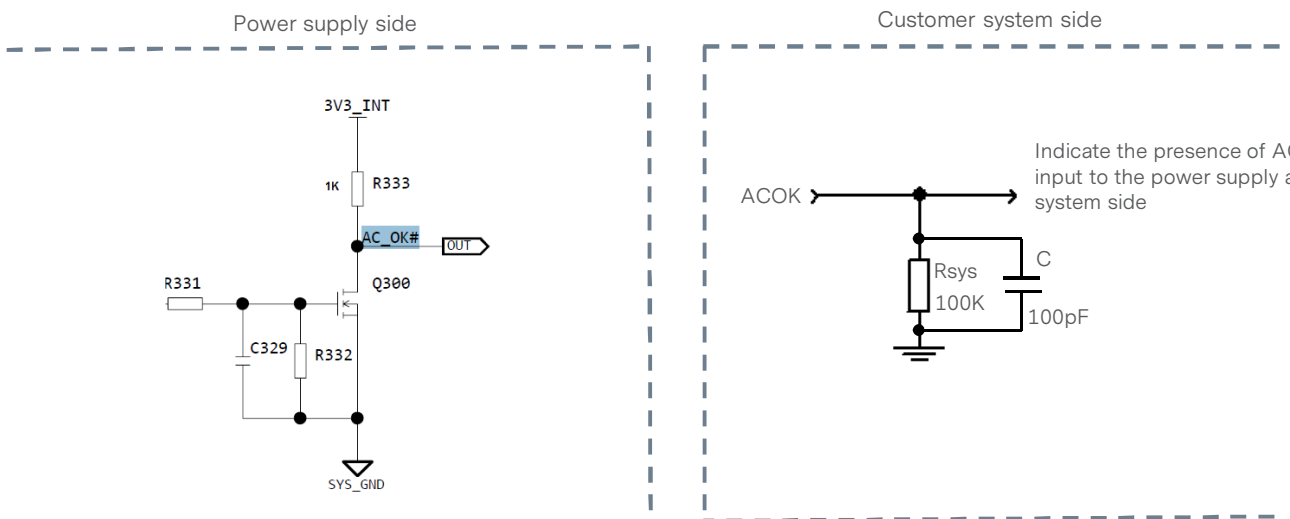

# POWER AND CONTROL SIGNAL DESCRIPTIONS

## I\_SHARE (Current Share Bus) - (Pin S7)

The DS1600SPE-3 supports active current sharing through a single wire connection between the power supplies. This input/output signal pin allows two or more power supplies to share the main output load current to increase the overall power capability or to operate the units in a N+N configuration for redundancy purposes.

The voltage of this signal will be a linear slope from no load to full load. At 66.6A output when two supplies are running in parallel must be between 3.85 and 4.15V. At 133.3A output when two supplies are running in parallel must be between 7.75 and 8.25V.

All outputs with active current sharing will share load current and the current share errors (CSE) are fixed 5% of the full load rating at 100%, 50%, 20% and 10% rated load respectively. Example: The maximum rated output current of an output is 133A, then the difference between half of total load and supplies' current cannot be greater than  $\pm 6.67A/100\%$ ,  $\pm 6.67A/50\%$ ,  $\pm 6.67A/25\%$  and  $\pm 6.67A/10\%$  load. The current share loop should be activated when the output current exceed 10% of total load.

## PS\_ON\_L - (Pin S13)

This signal input pin controls the normal turning ON and Off of the main output of the DS1600SPE-3 power supply. The power supply main output ( $V_O$ ) will be enabled when this signal is pulled low ( $<0.8V$ ) by the system. The Power supply output (except  $V_{SB}$  output) will be disabled when this signal is pulled high ( $>2.0V$ ) or left open circuited. System side pull-up resistor is not required.

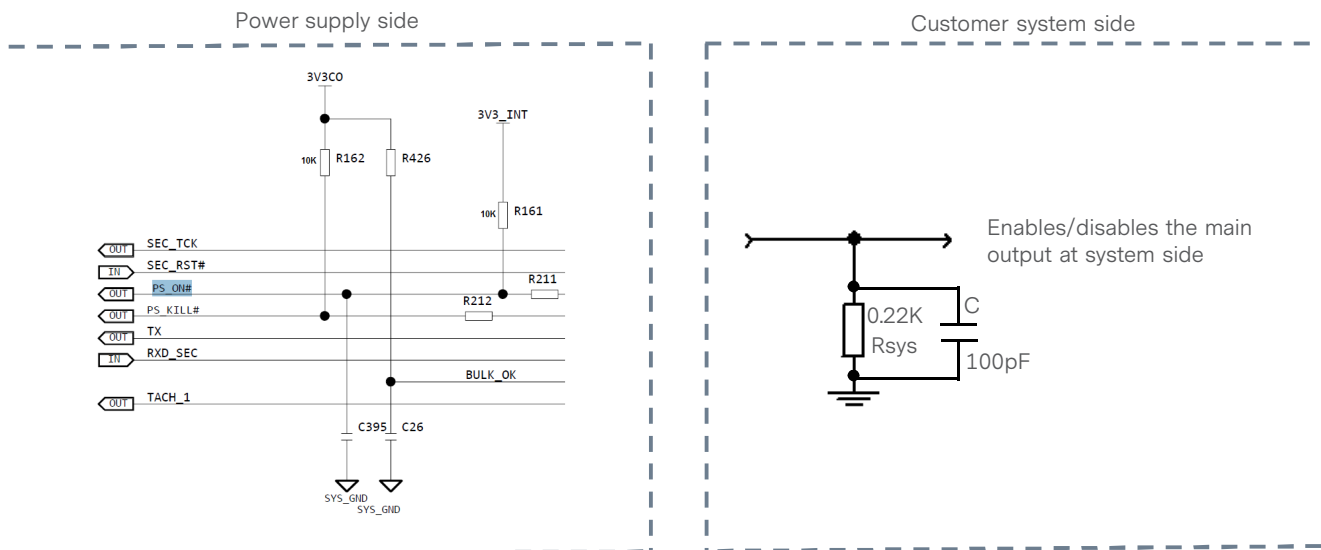

## POWER AND CONTROL SIGNAL DESCRIPTIONS

### PS\_KILL\_H - (Pin S14)

First break / last mate active LOW signal which enables/disables the main output. This signal will have to be pulled to ground at the system side with a 220ohm resistor. A 100pF decoupling capacitor is also recommended (standby output will remain on).

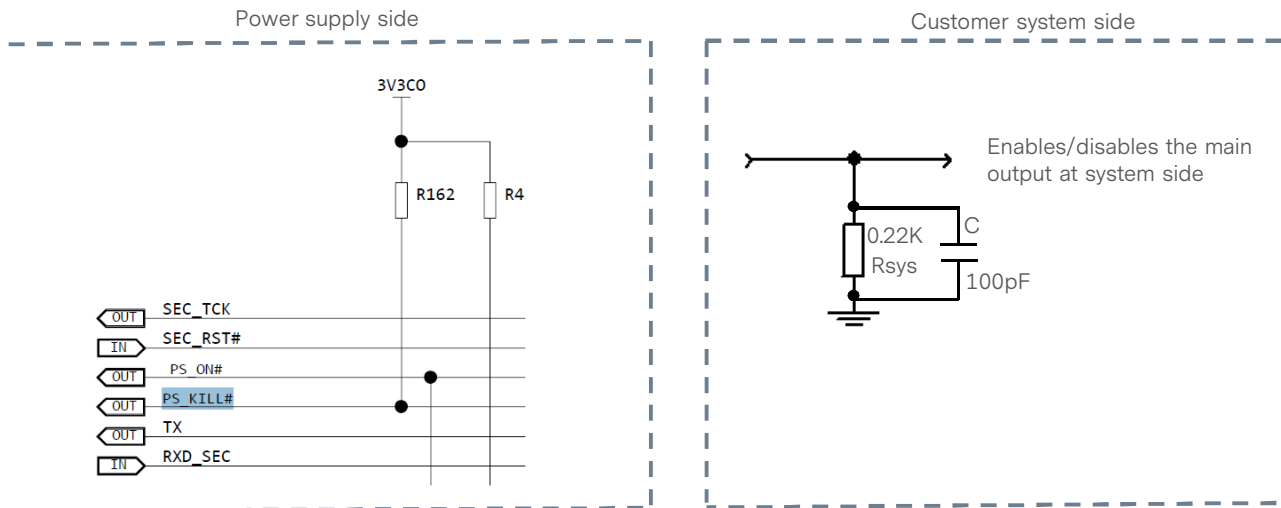

### SDA, SCL, and PS\_INTERRUPT\_L - (Pins S17, S19 and S9)

Please refer to "Communication Bus Descriptions" section.

### Main Output Remote Sense Return, Main Output Remote Sense - (Pins S21, S23)

The main output of the DS1600SPE-3 is equipped with a remote sensing capability that will compensate for a power path drop around the entire loop of 200 millivolt. This feature is implemented by connecting the main output remote sense (pin S23) and the main output remote sense return (pin S21) to the positive and negative rails of the main output, respectively, at a location that is near to the load. Care should be taken in the routing of the sense lines as any noise sources or additional filtering components introduced into the voltage rail may affect the stability of the power supply. The DS1600SPE-3 will operate appropriately without the sense lines connected; however it is recommended that the sense lines be connected directly to the main output terminals if remote sensing is not required. This remote sense circuit will not raise the power supply's output voltage to the OVP trip level. Main output remote sense has no effect on the standby output ( $V_{SB}$ ).

12V main output and standby output return lines are connected together inside PSU and connected to PSU chassis directly. It is recommended to connect 12V return to system chassis on end system application for better common mode noise.

### Standby Output, Standby Output Return - (Pins P19-P20, P21-P28)

The DS1600SPE-3 provides a regulated 12V 3A auxiliary output voltage to power critical circuitry that must remain active regardless of the on/off status of the power supply's main output. The standby output ( $V_{SB}$ ) voltage is available whenever a valid AC input voltage is applied to the unit. The standby output is independently short circuit protected and is referenced to the standby output return pins (P21-P28). It is recommended to place a 1uF ceramic decoupling capacitor between "standby output" and "standby output return" as close to the PSU mating connector as possible.

## COMMUNICATION BUS DESCRIPTIONS

### I<sup>2</sup>C Bus Signals

The DS1600SPE-3 series power supply contains enhanced monitor and control functions implemented via the I<sup>2</sup>C bus. The DS1600SPE-3 series I<sup>2</sup>C functionality (PMBus™ and FRU data) can be accessed via the output connector control signals. The communication bus is powered either by the internal 3.3V supply or from an external power source connected to the standby output (i.e. accessing an unpowered power supply as long as the standby output of another power supply connected in parallel is on).

If units are connected in parallel or in redundant mode, the standby outputs must be connected together in the system. Otherwise, the I<sup>2</sup>C bus will not work properly when a unit is inserted into the system without the AC source connected.

Note: PMBus™ functionality can be accessed only when the PSU is powered up. Guaranteed communication I<sup>2</sup>C speed is 100KHz.

### SDA, SCL (I<sup>2</sup>C Data and Clock Signals) - (Pins S17, S19)

I<sup>2</sup>C serial data and clock bus - these pins are internally pulled up to internal 3.3V supply with a 8.45Kohm resistor. These pins must be pulled up in the system by an 2.2Kohm resistor to 3.3V and a 200pF decoupling capacitor at the system side.

Refer to the communication interface specifications for more details.

### PS\_INTERRUPT\_L - (Pin S9)

PS\_INTERRUPT\_L is used to send an alert signal to the system that a fault in the power supply occurred. This signal is normally logic level HIGH. It will go to a LOW logic level when a fault bit has been set in the power supply's status register. This event can be triggered by faults such as OVP, OCP, OTP and fan fault. This signal can be cleared by a CLEAR\_FAULT command. Recommended pull-up resistor to 12V<sub>SB</sub> is 8.2kohm with a 3.0kohm pull-down to ground. A 200pF decoupling capacitor is also recommended.

### I<sup>2</sup>C Bus Communication Interval

The interval between two consecutive I<sup>2</sup>C communications to the power supply must be at least 15ms to ensure proper monitoring functionality.

### I<sup>2</sup>C Bus Signal Integrity

The noise on the I<sup>2</sup>C bus (SDA, SCL lines) due to the power supply will be less than 400mV peak-to-peak. This noise measurement should be made with an oscilloscope bandwidth limited to 100MHz. Measurements must be made at the power supply output connector with 2.2Kohm resistors pulled up to standby output and 100pF ceramic capacitors to standby output return.

# COMMUNICATION BUS DESCRIPTIONS

## I<sup>2</sup>C Bus Internal Implementation, Pull-ups and Bus Capacitances

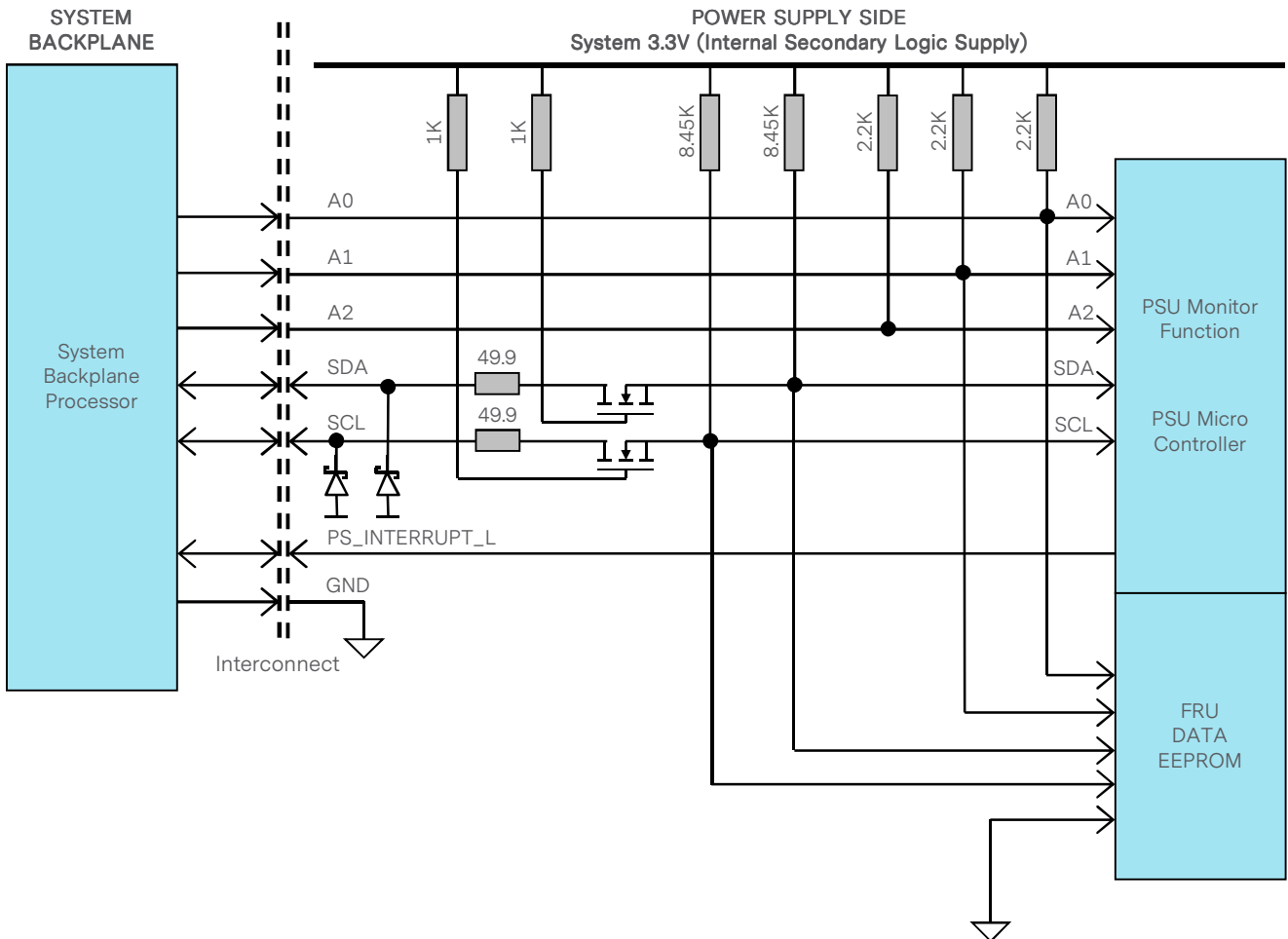

## I<sup>2</sup>C Bus - Recommended external pull-ups

Electrical and interface specifications of I<sup>2</sup>C signals (referenced to standby output return pin, unless otherwise indicated):

Parameter	Condition	Symbol	Min	Type	Max	Unit
SDA, SCL Internal Pull-up Resistor		$R_{int}$	-	8.45	-	Kohm
Recommended External Pull-up Resistor	1 to 4 PSU	$C_{ext}$ $R_{ext}$	-	200 2.2	-	pF Kohm

# COMMUNICATION BUS DESCRIPTIONS

## Logic Levels

DS1600SPE-3 series power supply I<sup>2</sup>C communication bus will respond to logic levels as per below:

Logic High: 5.1V nominal (Spec is 2.1V to 5.5V)\*\*

Logic Low: 500mV nominal (Spec is 800mV max)\*\*

## Timings

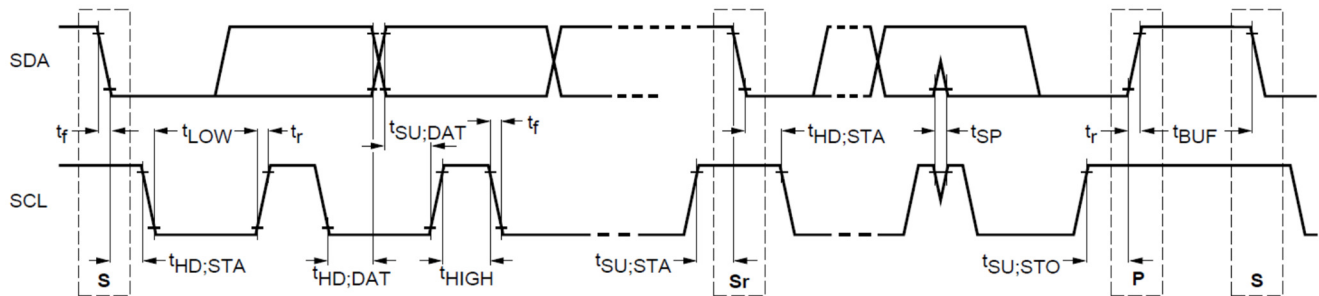

Parameter	Symbol	Standard-Mode Specs		Actual Measured	Unit
		Min	Max		
SCL clock frequency	$f_{SCL}$	0	100	100	KHz
Hold time (repeated) START condition	$t_{HD;STA}$	4.0	-	4.9	uS
LOW period of SCL clock	$t_{LOW}$	4.7	-	5.3	uS
HIGH period of SCL clock	$t_{HIGH}$	4.0	50	4.1	uS
Setup time for repeated START condition	$t_{SU;STA}$	4.7	-	20.4	uS
Data hold time	$t_{HD;DAT}$	0	3.45	1.7	uS
Data setup time	$t_{SU;DAT}$	250	-	4688	nS
Rise time	$t_r$	-	1000	SCL = 650 SDA = 650	nS
Fall time	$t_f$	-	300	SCL = 125 SDA = 211	nS
Setup time for STOP condition	$t_{SU;STO}$	4.0	-	6.9	uS
Bus free time between a STOP and START condition	$t_{BUF}$	4.7	-	62.1	mSec

## COMMUNICATION BUS DESCRIPTIONS

### Device Addressing

The DS1600SPE-3 series will respond to supported commands on the I<sup>2</sup>C bus that are addressed according to pins A2, A1 and A0 pins of output connector.

Address pins are held HIGH by default via pulled up to internal 3.3V (5V) supply with a 2.2K resistor. To set the address as “0”, the corresponding address line should be pulled down to logic ground level. Below tables show the address of the power supply with A0, A1 and A2 pins set to either “0” or “1”.

PSU Slot	Slot ID Bits			PMBus™ Address (W/R)	EEPROM (FRU) Address (W/R)
	A2	A1	A0		
1	0	0	0	0xB0/0xB1	0xA0/0xA1
2	0	0	1	0xB2/0xB3	0xA2/0xA3
3	0	1	0	0xB4/0xB5	0xA4/0xA5
4	0	1	1	0xB6/0xB7	0xA6/0xA7
5	1	0	0	0xB8/0xB9	0xA8/0xA9
6	1	0	1	0xBA/0xBB	0xAA/0xAB
7	1	1	0	0xBC/0xBD	0xAC/0xAD
8	1	1	1	0xBE/0xBF*	0xAE/0xAF*

\* Default PMBus™ address when A0, A1 and A2 are left open.



## COMMUNICATION BUS DESCRIPTIONS

### Reporting Functions

The power supply is capable of monitoring and controlling functions implemented via the I<sup>2</sup>C bus. This will use the SDA and SCL pins. The power supply monitor operates as an I<sup>2</sup>C slave device.

The accuracy of the report functions will be as follows:

Firmware Reporting And Monitoring			
Output loading	5% to 20%	20% to 50%	50% to 100%
Input voltage	±5%		
Input current	±0.55A fixed error	±5%	
Input power	±5W at <125W	±1.25%	
Output voltage	±2%		
Output current	±1.2A error for DS1600SPE <sup>1</sup>	±3%	
Temperature	±5°C on the operating range		
E <sub>IN</sub>	±15% from 10% to 20% load	±5%	
Fan speed	±250RPM		

PMBus	Yes
Remote ON/OFF	Yes

Note 1 - Reporting error shall not be more than 2A when the load is below 5%.

# COMMUNICATION BUS DESCRIPTIONS

## I<sup>2</sup>C Clock Synchronization

The DS1600SPE-3 series power supply applies clock stretching. An addressed slave power supply holds the clock line (SCL) low after receiving (or sending) a byte, indicating that it is not yet ready to process more data. The system master that is communicating with the power supply will attempt to raise the clock to transfer the next bit but must verify that the clock line was actually raised. If the power supply is clock stretching, the clock line will still be low (because the connections are open-drain).

The maximum time-out condition for clock stretching for DS1600SPE-3 series is 25 milliseconds.

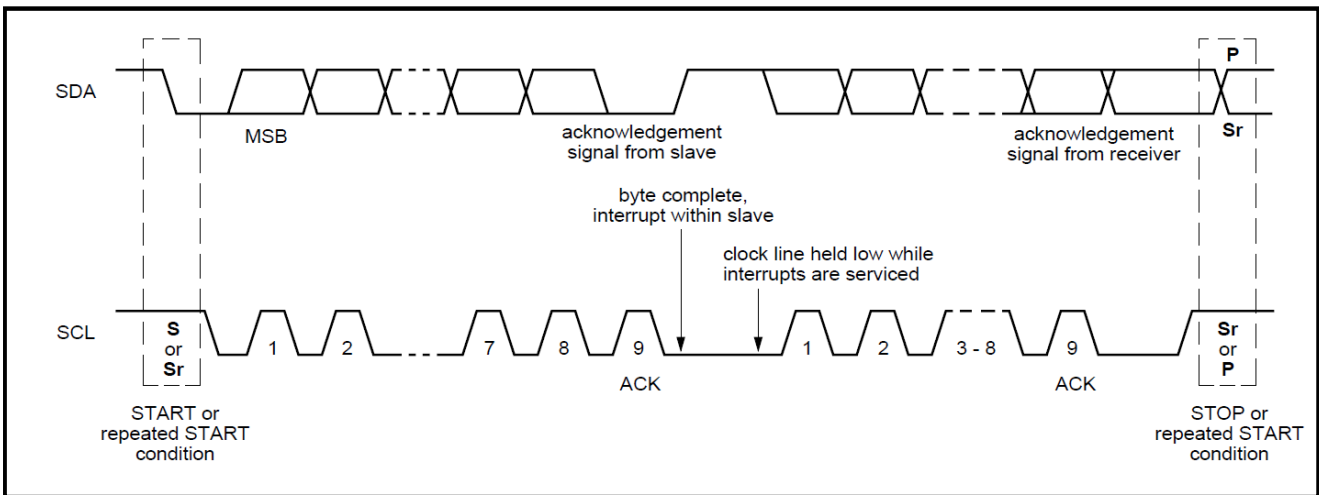

## COMMUNICATION BUS DESCRIPTIONS

### FRU (EEPROM) Data

The FRU (Field Replaceable Unit) data format is compliant with the Intel IPMI v1.0 specification. The DS1600SPE-3 uses 1 page of EEPROM for FRU purpose. The one page of EEPROM contains up to 256 byte-sized data locations.

Where:	OFFSET	-The OFFSET denotes the address in decimal format of a particular data byte within DS1600SPE-3 EEPROM.
	VALUE	-The VALUE details data written to a particular memory location of the EEPROM.
	DEFINITION	-The contents DEFINITION refers to the definition of a particular data byte.

DS1600SPE-3 series FRU (EEPROM) Data:

OFFSET		DEFINITION	SPEC VALUE	
(DEC)	(HEX)	(REMARKS)	(DEC)	(HEX)
<b>COMMON HEADER, 8 BYTES</b>				
0	00	<b>FORMAT VERSION NUMBER</b> (Common header) 7:4 - Reserved, write as 0000b 3:0 - Format version number = 1h for this specification	1	01
1	01	<b>INTERNAL USE AREA OFFSET</b>	27	1B
2	02	<b>CHASSIS INFO AREA OFFSET</b>	1	1
3	03	<b>BOARD INFO AREA OFFSET</b>	0	00
4	04	<b>PRODUCT INFO AREA OFFSET</b>	5	05
5	05	<b>MULTI RECORD AREA OFFSET</b>	13	0D
6	06	<b>PAD</b> (Reserved - Default value is 0.)	0	00
7	07	<b>ZERO CHECK SUM</b> (256 - (Sum of bytes 0 to 6))	209	D1
<b>CHASSIS INFO AREA (32 BYTES)</b> This area will be filled by the Mfg. Diag. or by the OS if used.				
8	08	<b>FORMAT VERSION NUMBER</b> (Default value is 0.) 7:4 - Reserved, write as 0000b 3:0 - Format version number = 1h for this specification	1	01
9	09	<b>CHASSIS INFO AREA LENGTH</b> in multiple of 8 bytes	4	04
10	0A	<b>CHASSIS TYPE</b> (Default value is 0.)	0	00
11	0B	<b>CHASSIS PART NUMBER</b> Type/Length CAh (if used) Type = "ASCII+LATIN1" = (11)b length = 10 bytes = (001010)b	202	CA
12	0C	<b>CHASSIS PART NUMBER BYTES</b> (Default value is 0.)	0	00
13	0D		0	00
14	0E		0	00
15	0F		0	00
16	10		0	00
17	11		0	00
18	12		0	00
19	13		0	00
20	14		0	00
21	15		0	00
22	16	<b>CHASSIS SERIAL NUMBER</b> Type/Length CFH (if used) Type = "ASCII+LATIN1" = (11)b length = 15 bytes = (001111)b	207	CF
23	17	<b>CHASSIS SERIAL NUMBER BYTES</b> , default value is 0.	0	00
24	18		0	00
25	19		0	00
26	1A		0	00
27	1B		0	00
28	1C		0	00
29	1D		0	00
30	1E		0	00
31	1F		0	00

## COMMUNICATION BUS DESCRIPTIONS

DS1600SPE-3 series FRU (EEPROM) Data:

OFFSET		DEFINITION (REMARKS)	SPEC VALUE	
(DEC)	(HEX)		(DEC)	(HEX)
32	20	<b>CHASSIS SERIAL NUMBER BYTES</b> , default value is 0.	0	00
33	21		0	00
34	22		0	00
35	23		0	00
36	24		0	00
37	25		0	00
38	26		<b>End Tag</b> (0C1h if used)	193
39	27	<b>CHKSUM</b> (Zero CHKSUM if used)	161	A1
<b>PRODUCT INFORMATION AREA, 64 BYTES</b>				
40	28	<b>FORMAT VERSION NUMBER</b> (Product Info Area) 7:4 - Reserved, write as 0000b 3:0 - Format Version Number = 1h for this specification	1	01
41	29	<b>PRODUCT INFO AREA LENGTH</b> (In multiples of 8 bytes)	8	08
42	2A	<b>Language (English)</b>	25	19
43	2B	<b>MANUFACTURER NAME TYPE/LENGTH</b> (0C5H) 7:6 - (11)b, 8-bit ASCII+Latin 1, 5:0 - (000101)b, 5-byte allocation	199	C7
44	2C	<b>MANUFACTURER'S NAME</b> 5 bytes sequence "A" = 41h "R" = 52h "T" = 54h "E" = 45h "S" = 53h "Y" = 59h "N" = 4Eh	65	41
45	2D		82	52
46	2E		84	54
47	2F		69	45
48	30		83	53
49	31		89	59
50	32		78	4E
51	33	<b>PRODUCT NAME</b> Type/Length (CCH) Type = "ASCII+LATIN1" = (11)b length = 15 bytes = (001111)b	207	CF
52	34	<b>PRODUCT NAME BYTES</b> (5 bytes sequence) "D" "S" "1" "6" "0" "0" "S" "P" "E" "_" "3"	68	44
53	35		83	53
54	36		49	31
55	37		54	36
56	38		48	30
57	39		48	30
58	3A		83	53
59	3B		80	50
60	3C		69	45
61	3D		45	2D
62	3E		51	33
63	3F		32	20
64	40		32	20
65	41		32	20
66	42		32	20
67	43	<b>PRODUCT PART/MODEL NUMBER</b> Type/Length (CFH) Type = "ASCII+LATIN1" = (11)b length = 15 bytes = (001111)b	207	CF

## COMMUNICATION BUS DESCRIPTIONS

DS1600SPE-3 series FRU (EEPROM) Data:

OFFSET		DEFINITION (REMARKS)	SPEC VALUE	
(DEC)	(HEX)		(DEC)	(HEX)
68	44	<b>PRODUCT PART/MODEL NUMBER BYTES</b> "D" "S" "1" "6" "0" "0" "S" "P" "E" "_" "3"	68	44
69	45		83	53
70	46		49	31
71	47		54	36
72	48		48	30
73	49		48	30
74	4A		83	53
75	4B		80	50
76	4C		69	45
77	4D		45	2D
78	4E		51	33
79	4F		32	20
80	50		32	20
81	51		32	20
82	52		32	20
83	53	<b>PRODUCT VERSION NUMBER</b> Type/Length (C2h) Type = "ASCII+LATIN1" = (11)b length = 2 bytes = (000010)b	194	C2
		<b>PRODUCT VERSION NUMBER BYTES</b> Refer to Section 1.2 Product Revision History in latest IPS		
84	54	"A"	65	41
85	55	"A"	65	41
86	56	<b>PRODUCT SERIAL NUMBER</b> Type/Length Type = "ASCII+LATIN1" = (11)b Length = 13 bytes = (001101)b	205	CD
		<b>PRODUCT SERIAL NUMBER BYTES</b> Model ID = DS1600SPE-3 / K369		
87	57	"K"	75	4B
88	58	"3"	51	33
89	59	"6"	54	36
90	5A	"9"	57	39
91	5B	<b>MANUFACTURING YEAR AND WEEK CODE</b> "W" = 57h (Per Unit)	87	57
92	5C	"W" = 57h (Per Unit)	87	57
		<b>UNIQUE SERIAL NUMBER</b> "SSSS"		
93	5D	"S" = 53 (Per Unit)	83	53
94	5E	"S" = 53 (Per Unit)	83	53
95	5F	"S" = 53 (Per Unit)	83	53
96	60	"S" = 53 (Per Unit)	83	53
		<b>MODEL REVISION</b> , Astec Model Rev, see latest model rev in IPS sec 1.2		
97	61	"A"	65	41
98	62	"A"	65	41
99	63	<b>MANUFACTURING LOCATION</b> "Z" for "Zhonshan, China" In Decimal = 090 In Hex = 5AH	90	5A
100	64	<b>End Tag</b>	193	C1
101	65	<b>PAD (reserved), default value is 0.</b>	0	00
102	66		0	00
103	67	<b>ZERO CHECK SUM (256 - (Sum of bytes 40 to 102)) Per Unit</b> Zero Check Sum: Should follow check sum calculation as per IPMI v1.1 specs.	187	BB

## COMMUNICATION BUS DESCRIPTIONS

DS1600SPE-3 series FRU (EEPROM) Data:

OFFSET		DEFINITION (REMARKS)	SPEC VALUE	
(DEC)	(HEX)		(DEC)	(HEX)
<b>MULTI RECORD AREA, 88 BYTES</b>				
104	68	<b>Power Supply Record Header</b> Record type = 00 for power supply	0	00
105	69	End of List / Record Format Version Number	2	02
106	6A	Record length of power supply record	24	18
107	6B	Record CHECKSUM of power supply record (Zero CHECKSUM) (256-(sum of bytes 109 to 132))	23	17
108	6C	Header CHECKSUM of power supply record header (Zero CHECKSUM) (256-(sum of bytes 104 to 107))	207	CF
<b>POWER SUPPLY RECORD</b>				
109	6D	<b>Overall Capacity of The Power Supply</b> 2 bytes sequence 1600W = 0640H In Decimal = 64, 06 In Hex = 40H, 06H	64	40
110	6E		06	06
111	6F	<b>Peak VA, 1834W = 072AH</b> 2 bytes sequence In Decimal = 42, 07 In Hex = 2AH, 07H	42	2A
112	70		07	07
113	71	<b>Inrush Current, 55A</b> In Decimal = 055 In Hex = 37H	55	37
114	72	<b>Inrush Interval, 10mS</b> In Decimal = 010 In Hex = 0AH	10	0A
115	73	<b>Low End Input Voltage Range 1(10mV), (90V/10mV) 9000 = 2328H</b> 2 bytes sequence In Decimal = 040, 035 In Hex = 28H, 23H	40	28
116	74		35	23
117	75	<b>High End Input Voltage Range 1(10mV), (264V/10mV) 26400 = 6720H</b> 2 bytes sequence In Decimal = 032, 103 In Hex = 20H, 67H	32	20
118	76		103	67
119	77	<b>Low End Input Voltage Range 2(10mV)</b> Not applicable (Autoswitch)	0	00
120	78		0	00
121	79	<b>High End Input Voltage Range 2(10mV)</b> Not applicable (Autoswitch)	0	00
122	7A		0	00
123	7B	<b>Low End Input Frequency Range, 47Hz = 2FH</b>	47	2F
124	7C	<b>Low End Input Frequency Range, 63Hz = 3FH</b>	63	3F
125	7D	<b>AC Dropout Tolerance in ms, 10mS = 0AH</b>	10	0A
126	7E	<b>Binary Flags, "1" indicates function supported and "0" indicates function not supported.</b> Bits 7-5: RESERVED, write as 000B. Bit 5: PMBUS capable or not. 1 if supported 0 if not. BIT = 1 Bit 4: Tachometer Pulses Per Rotation / Predictive Fail Polarity BIT = 0 Bit 3: Hot Swap / Redundancy Support BIT = 1 Bit 2: Auto Switch Support BIT = 1 Bit 1: Power Factor Correction Support BIT = 1 Bit 0: Predictive Fail Support BIT = 0	46	2E
127	7F	<b>Peak Wattage Capacity and Holdup Time</b> 2 bytes sequence 1600W = 0640H 10ms = 0BH	64	40
128	80		166	A6

## COMMUNICATION BUS DESCRIPTIONS

DS1600SPE-3 series FRU (EEPROM) Data:

OFFSET		DEFINITION (REMARKS)	SPEC VALUE	
(DEC)	(HEX)		(DEC)	(HEX)
129	81	<b>Combined Wattage</b> , not applicable Byte 1: 0000 0000 0000 0000 Byte 2 and Byte 3: 00H, 00H 3 bytes sequence	0	00
130	82		0	00
131	83		0	00
132	84	<b>Predictive Fail Tachometer Lower Threshold</b> , not applicable Predictive failure is not supported.	0	00
<b>12V DC OUTPUT RECORD HEADER</b>				
133	85	Record Type = 01 for DC Output Record	1	01
134	86	End of List / Record Format Version Number for 12V DC Output Record	2	02
135	87	Record Length of 12V DC Output Record	13	0D
136	88	Record CHECKSUM of 12V DC Output Record (Zero CHECKSUM) (256-(sum of bytes 138 to 150))	60	3C
137	89	Header CHECKSUM of 12V DC Output Record Header (Zero CHECKSUM) (256-(sum of bytes 131 to 136))	180	B4
<b>12V OUTPUT RECORD</b>				
138	8A	<b>Output Information, 001 = 01H</b> Bit 7: Standby Information = 0B Bits 6-4: Reserved, write as 000B Bits 3-0: Output Number 1 = 001B	1	01
139	8B	<b>Nominal Voltage (10mV), (12V / 10mV) 1200 = 04B0H</b> 2 bytes sequence In Decimal: 176, 004 In Hex: B0H, 04H	176	B0
140	8C		4	04
141	8D	<b>Maximum Negative Voltage Deviation (10mV), 1140 = 0474H</b> 2 bytes sequence In Decimal: 116, 004 In Hex: 74H, 04H	116	74
142	8C		4	04
143	8F	<b>Maximum Positive Voltage Deviation (10mV), 1260 = 04ECH</b> 2 bytes sequence In Decimal: 236, 004 In Hex: ECH, 04H	236	EC
144	90		4	04
145	91	<b>Ripple and Noise pk-pk (mV), 150 = 96H</b> 2 bytes sequence In Decimal: 150, 000 In Hex: 96H, 00H	120	78
146	92		0	00
147	93	<b>Minimum Current Draw (10mA), 0200 = 00C8H</b> 2 bytes sequence In Decimal: 050, 000 In Hex: 32H, 00H	200	C8
148	94		0	00
149	95	<b>Maximum Current Draw (10mA), 6250 = 3415H</b> In Decimal: 21, 52 In Hex: 15H, 34H	21	15
150	96		52	34
<b>VSB OUTPUT RECORD HEADER</b>				
151	97	Record Type = 01 for DC Output Record	1	01
152	98	End of List / Record Format Version Number for 3V3SB Output Record	2	02
153	99	Record Length of 3V3SB Output Record	13	0D
154	9A	Record CHECKSUM of 3V3SB Output Record (Zero CHECKSUM) (256-(sum of bytes 156 to 168))	179	B3
155	9B	Header CHECKSUM of 3V3SB Output Record Header (Zero CHECKSUM) (256-(sum of bytes 151 to 154))	61	3D

## COMMUNICATION BUS DESCRIPTIONS

DS1600SPE-3 series FRU (EEPROM) Data:

OFFSET		DEFINITION (REMARKS)	SPEC VALUE	
(DEC)	(HEX)		(DEC)	(HEX)
156	9C	<b>Output Information</b> , 002 = 02H Bit 7: Standby Information = 1B Bits 6-4: Reserved, write as 000B Bits 3-0: Output Number 2 = 010B	130	82
157	9D	<b>Nominal Voltage (10mV)</b> , (12V/10mV) 1200 = 04B0H 2 bytes sequence In Decimal: 176, 004 In Hex: B0H, 04H	176	B0
158	9E		4	04
159	9F	<b>Maximum Negative Voltage Deviation (10mV)</b> , 1140 = 0474H 2 bytes sequence In Decimal: 116, 004 In Hex: 74H, 04H	116	74
160	A0		4	04
161	A1	<b>Maximum Positive Voltage Deviation (10mV)</b> , 1260 = 04ECH 2 bytes sequence In Decimal: 236, 004 In Hex: ECH, 04H	236	EC
162	A2		4	04
163	A3	<b>Ripple and Noise pk-pk (mV)</b> , 120 = 78H 2 bytes sequence In Decimal: 120, 000 In Hex: 78H, 00H	120	78
164	A4		0	00
165	A5	<b>Minimum Current Draw (10mA)</b> , (0.1A/10mA) 10 = 000AH 2 bytes sequence In Decimal: 010, 000 In Hex: 0AH, 00H	176	B0
166	A6		4	04
167	A7	<b>Maximum Current Draw (10mA)</b> , (3.5A/10mA) 350 = 015EH 2 bytes sequence In Decimal: 94, 001 In Hex: 5EH, 01H	116	74
168	A8		4	04
<b>OEM RECORD HEADER</b>				
169	A9	Record Type = C0H for OEM Record	192	C0
170	AA	End of List / Record Format Version Number for 3.3Vsb Output Record	130	82
171	AB	Record Length of OEM Record	42	2A
172	AC	Record CHECKSUM of OEM Record (Zero CHECKSUM)	0	00
173	AD	Header CHECKSUM of OEM Record Header (Zero CHECKSUM) (256-(sum of bytes 169 to 172))	148	94
<b>OEM RECORD</b>				
174	AE	<b>Manufacturer ID</b> (3 bytes, default is 0)	0	00
175	AF	RESERVED	0	00
176	B0	RESERVED	0	00
177	B1	RESERVED	0	00
178	B2	RESERVED	0	00
179	B3	RESERVED	0	00
180	B4	RESERVED	0	00
181	B5	RESERVED	0	00
182	B6	RESERVED	0	00
183	B7	RESERVED	0	00
184	B8	RESERVED	0	00
185	B9	RESERVED	0	00
186	BA	RESERVED	0	00
187	BB	PAD (reserved), default value is 0.	0	00
188	BC		0	00
189	BD		0	00
190	BE		0	00
191	BF		0	00
192	C0		0	00
193	C1		0	00



## COMMUNICATION BUS DESCRIPTIONS

DS1600SPE-3 series FRU (EEPROM) Data:

OFFSET		DEFINITION (REMARKS)	SPEC VALUE	
(DEC)	(HEX)		(DEC)	(HEX)
194	C2	PAD (reserved), default value is 0.	0	00
195	C3		0	00
196	C4		0	00
197	C5		0	00
198	C6		0	00
199	C7		0	00
200	C8		0	00
201	C9		0	00
202	CA		0	00
203	CB		0	00
204	CC		0	00
205	CD		0	00
206	CE		0	00
207	CF		0	00
208	D0		0	00
209	D1		0	00
210	D2		0	00
211	D3	0	00	
212	D4	0	00	
213	D5	0	00	
214	D6	0	00	
215	D7	0	00	
<b>INTERNAL USE AREA, 40 BYTES</b>				
216	D8	<b>FORMAT VERSION NUMBER</b> 7:4 - Reserved, write as 0000b 3:0 - Format Version Number = 1h for this specification	1	1
217	D9	INTERNAL USE AREA LENGTH in multiple of 8 bytes	5	5
218	DA	RESERVED, default value is 0.	0	00
219	DB		0	00
220	DC		0	00
221	DD		0	00
222	DE		0	00
223	DF		0	00
224	E0		0	00
225	E1		0	00
226	E2		0	00
227	E3		0	00
228	E4		0	00
229	E5		0	00
230	E6		0	00
231	E7		0	00
232	E8		0	00
233	E9		0	00
234	EA		0	00
235	EB	0	00	
236	EC	0	00	
237	ED	0	00	
238	EE	0	00	
239	EF	0	00	
240	F0	0	00	
241	F1	0	00	
242	F2	0	00	
243	F3	0	00	
244	F4	0	00	
245	F5	0	00	
246	F6	0	00	
247	F7	0	00	
248	F8	0	00	

## COMMUNICATION BUS DESCRIPTIONS

DS1600SPE-3 series FRU (EEPROM) Data:

OFFSET		DEFINITION (REMARKS)	SPEC VALUE	
(DEC)	(HEX)		(DEC)	(HEX)
249	F9	RESERVED, default value is 0.	0	00
250	FA		0	00
251	FB		0	00
252	FC		0	00
253	FD		0	00
254	FE		0	00
255	FF	Zero CHECKSUM of Internal Use Area (if used). Default Value = 0	250	FA

## COMMUNICATION BUS DESCRIPTIONS

DS1600SPE-3-001 FRU (EEPROM) Data:

OFFSET		DEFINITION (REMARKS)	SPEC VALUE	
(DEC)	(HEX)		(DEC)	(HEX)
		<b>PRODUCT NAME BYTES</b> (5 bytes sequence)		
52	34	"D"	68	44
53	35	"S"	83	53
54	36	"1"	49	31
55	37	"6"	54	36
56	38	"0"	48	30
57	39	"0"	48	30
58	3A	"S"	83	53
59	3B	"P"	80	50
60	3C	"E"	69	45
61	3D	"_"	45	2D
62	3E	"3"	51	33
63	3F	"_"	45	2D
64	40	"0"	48	30
65	41	"0"	48	30
66	42	"1"	49	31
67	43	<b>PRODUCT PART/MODEL NUMBER</b> Type/Length (CFH) Type = "ASCII+LATIN1" = (11)b length = 15 bytes = (001111)b	207	CF
		<b>PRODUCT PART/MODEL NUMBER BYTES</b>		
68	44	"D"	68	44
69	45	"S"	83	53
70	46	"1"	49	31
71	47	"6"	54	36
72	48	"0"	48	30
73	49	"0"	48	30
74	4A	"S"	83	53
75	4B	"P"	80	50
76	4C	"E"	69	45
77	4D	"_"	45	2D
78	4E	"3"	51	33
79	4F	"_"	45	2D
80	50	"0"	48	30
81	51	"0"	48	30
82	52	"1"	49	31

## PMBus™ SPECIFICATIONS

The DS1600SPE-3 series is compliant with the industry standard PMBus™ protocol for monitoring and control of the power supply via the I<sup>2</sup>C interface port.

### DS1600SPE-3 Series PMBus™ General Instructions

#### Equipment Setup

The following is typical I<sup>2</sup>C communication setup:

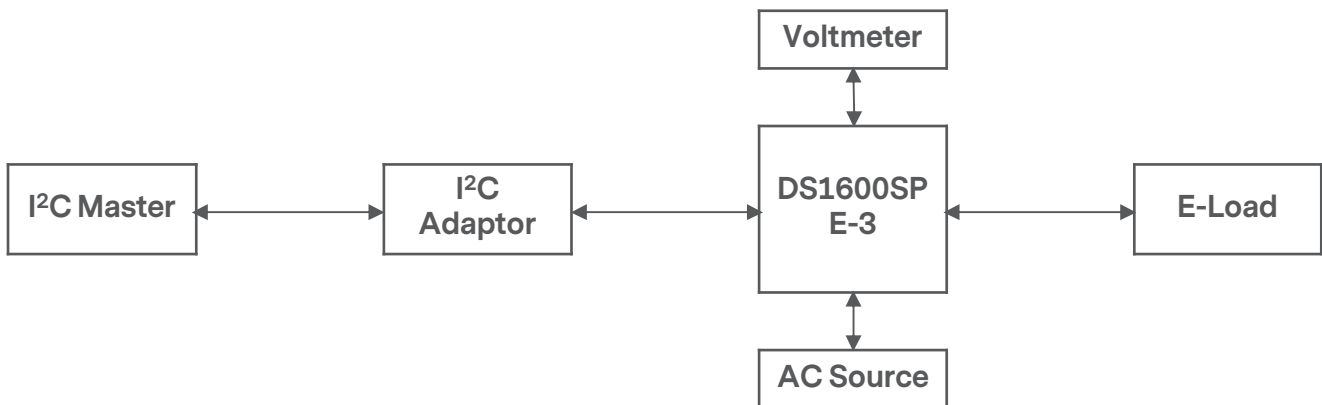

#### PMBus™ Writing Instructions

When writing to any PMBus™ R/W registers, always do the following:

Disable write protect (command 10h) by writing any of the following accordingly:

- Levels:
- 00h - Enable writing to all writeable commands
  - 20h - Disables write except 10h, 01h, 00h, 02h and 21h commands
  - 40h - Disables write except 10h, 01h, and 00h commands
  - 80h - Disable write except 0x00h

To save changes on the USER PMBus™ Table:

Use send byte command: 15h STORE\_USER\_ALL

To save changes on the DEFAULT PMBus™ Table:

Use send byte command: 11h STORE\_DEFAULT\_ALL

Wait for 5 seconds, turn off the PSU, wait for another 5 seconds before turning it on.

## PMBus™ SPECIFICATIONS

The DS1600SPE-3 Series Supported PMBus™ Command List:

Command Code	Command Name	Default Value	Access Type	Data Bytes	Data Format	Description
00h	PAGE	00	R	1		
01h	OPERATION	80	R/W	1		Used to turn the unit ON/OFF in conjunction with the input CONTROL pin. It is also used to set output to upper or lower margin voltages.
	b7:6	10				01 - Soft turn OFF (With sequencing) 10 - PSU ON
	b5:4	00				
	b3:2	00				
	b1:0	00				Reserved
02h	ON_OFF_CONFIG	1C	R/W	1		Configures the combination of CONTROL pin and serial communication commands needed to turn the unit ON/OFF.
	b7:5	000				Reserved
	b4 - Enable CONTROL pin and serial communication control.	1				0 - Unit powers up any time power is present regardless of the state of CONTROL pin. 1 - Unit powers up as dictated by CONTROL pin and OPERATION command (b3:0).
	b3 - Serial communication control	1				0 - Unit ignores ON/OFF portion of the OPERATION command. 1 - Enables serial communication ON/OFF portion of OPERATION command. Requires CONTROL pin to be asserted for the unit to start and energize the output.
	b2 - Sets how the unit responds to CONTROL pin	1				0 - Unit ignores CONTROL pin. (ON/OFF controlled by OPERATION command). 1 - Unit requires CONTROL pin to be asserted to start the unit.
	b1 - CONTROL pin polarity	0				0 - Active low (Pull low to start the unit) 1 - Active high (Pull high to start the unit)
	b0 - CONTROL pin action	0				0 - Use programmed turn ON/OFF delay. 1 - Turn OFF the output and stop transferring energy to the output as fast as possible.
03h	CLEAR_FAULTS	FF	S			
10h	WRITE_PROTECT	80	R/W	1		Used to control writing to the PMBus™ device. 80h - Disables write except 10h 40h - Disables write except 10h, 01h, 00h 20h - Disables write except 10h, 01h, 00h, 02h and 21h commands. 00 - Enables write to all writeable commands.

## PMBus™ SPECIFICATIONS

The DS1600SPE-3 Series Supported PMBus™ Command List:

Command Code	Command Name	Default Value	Access Type	Data Bytes	Data Format	Description
15h	STORE_USER_ALL	-	S	0		Copies the operating memory table to the matching USER non-volatile memory.
19h	CAPABILITY	90	R	1		Provides a way for the hosts system to determine some key capabilities of a PMBus™ device.
	b7 - Packet Error Checking	1				0 - PEC not supported 1 - PEC supported
	b6 - Maximum Bus Speed	0				0 - Maximum supported bus speed, 100KHz 1 - Maximum supported bus speed, 400KHz
	b5 - SMBALERT	0				0 - SMBus Alert Pin not supported. 1 - SMBus Alert Pin supported.
	b4:0	00000				Reserved
20h	VOUT_MODE	17	R	1		Specifies the mode and parameters of output voltage related data formats.
21h	VOUT_COMMAND	1800	R/W	2	Linear	Sets the output voltage reference. Vout command sends discreet value to change or trim output voltage. Valid range is 11.4 to 12.6V.
24h	VOUT_MAX	1933	R	2	Linear	Read Only (12.6V)
30h	COEFFICIENTS	-	BW	6	Hex	Use to retrieve the m, b and R coefficients, needed for DIRECT data format.
	byte 5					R byte
	byte 4:3					b low byte, b high byte
	byte 2:1					m low byte, m high byte
35h	VIN_ON	EAC0	R	2	Linear	Sets the value of input, in volts, at which the unit should start. ACGOOD 88Vac
36h	VIN_OFF	EA98	R	2	Linear	Sets the value of input, in volts, at which the unit should stop power conversion. ACBAD 83Vac
3Ah	FAN_CONFIG_1_2	90	R	1	Bitmapped	Read only to reflect setting of fans.
	b7	1				1 - Fan is installed in position 1. 0 - No fan is installed in position 1.
	b6	0				1 - Fan is commanded in RPM. 0 - Fan is commanded in DC.
	b5:4	01				00 - 1 pulse per revolution 01 - 2 pulses per revolution 10 - 3 pulses per revolution 11 - 4 pulses per revolution
	b3	0				1 - Fan is installed in position 2. 0 - No fan is installed in position 2.

## PMBus™ SPECIFICATIONS

The DS1600SPE-3 Series Supported PMBus™ Command List:

Command Code	Command Name	Default Value	Access Type	Data Bytes	Data Format	Description
3Ah	b2	0				1 - Fan is commanded in RPM. 0 - Fan is commanded in DC.
	b1:0	00				00 - 1 pulse per revolution 01 - 2 pulses per revolution 10 - 3 pulses per revolution 11 - 4 pulses per revolution
3Bh	FAN_COMMAND_1	0000	R/W	2	Linear	Adjusts the operation of the fans. The device may override the command, if it requires higher value, to maintain proper device temperature. Duty cycle control - Commands speeds from 0 to 100%.
40h	VOUT_OV_FAULT_LIMIT	1B99	R/W	2	Linear	Sets output over voltage threshold. (13.8V) Valid Range: 12.6 to 15.5V
41h	VOUT_OV_FAULT_RESPONSE	80	R	1		Unit latches OFF. Resets on PSON or CONTROL pin recycle or AC recycle.
42h	VOUT_OV_WARN_LIMIT	1999	R/W	2	Linear	Sets over-voltage warning threshold. (12.8V)
43h	VOUT_UV_WARN_LIMIT	1666	R/W	2	Linear	Sets under-voltage warning threshold. (11.2V)
44h	VOUT_UV_FAULT_LIMIT	1599	R/W	2	Linear	Sets under-voltage fault threshold. (10.8V)
45h	VOUT_UV_FAULT_RESPONSE	80	R	1		Turn PSU OFF
46h	IOUT_OC_FAULT_LIMIT	F280	R/W	2	Linear	Sets the over current threshold in Amps. (160A) Valid Range: 150 to 166.7A
47h	IOUT_OC_FAULT_RESPONSE	C0	R	1		OCP ride through. If OCP persists.
4Ah	IOUT_OC_WARN_LIMIT	F258	R	2	Linear	Sets the over current warning threshold in Amps. (150A) Valid Range: 150 to 166.7A
4Fh	OT_FAULT_LIMIT	EBC0	R/W	2	Linear	Secondary ambient temperature fault threshold, in degree C. (120degC) Valid Range: 51 to 125degC
50h	OT_FAULT_RESPONSE	78	R	1	Bitmapped	Turn PSU OFF and will retry indefinitely. Supported enable/disable of protection and recoverability.
51h	OT_WARN_LIMIT	EB98	R/W	2	Linear	Secondary ambient temperature warning threshold, in degree C. Operating limit (115degC) Valid Range: 51 to 125degC
55h	VIN_OV_FAULT_LIMIT	FA26	R/W	2	Linear	Sets input over-voltage threshold. (275Vac) Valid Range: 264 to 300Vac
56h	VIN_OV_FAULT_RESPONSE	F8	R	1	Bitmapped	

## PMBus™ SPECIFICATIONS

The DS1600SPE-3 Series Supported PMBus™ Command List:

Command Code	Command Name	Default Value	Access Type	Data Bytes	Data Format	Description
57h	VIN_OV_WARN_LIMIT	FA1C	R/W	2	Linear	Default: 270Vac. Valid Range: 264 to 300Vac
58h	VIN_UV_WARN_LIMIT	EAB8	R/W	2	Linear	Default: 87Vac. Valid Range: 70 to 90Vac
59h	VIN_UV_FAULT_LIMIT	EA98	R/W	2	Linear	Default: 83Vac Valid Range: 70 to 90Vac
5Ah	VIN_UV_FAULT_RESPONSE	F8	R	1	Bitmapped	
5Eh	POWER_GOOD_ON	16CC	R/W	2	Linear	Sets the threshold by which the Power Good Default: 11.4V, Valid Range: 11.4 to 12.6V
5Fh	POWER_GOOD_OFF	1666	R/W	2	Linear	Sets the threshold by which the Power Good Default: 11.2V Valid Range <= 11.4V
60h	TON_DELAY	EB20	R/W	2	Linear	Sets the time (sec), from start condition (Power ON) until the output starts to rise. (2.1sec max) Default=100ms
61h	TON_RISE	E280	R	2	Linear	Sets the time (ms), for the output rises from 0 to regulation. (50ms max) Default=40ms
62h	TON_MAX_FAULT_LIMIT		R/W	2	Linear	Default: 2.2S, Valid Range: 2 to 2.5S
63h	TON_MAX_FAULT_RESPONSE	80	R	2	Bitmapped	
64h	TOFF_DELAY	C200	R/W	2	Linear	Sets the time (ms), from a stop condition (Power OFF) until the output starts to drop (converter OFF). Default: 2.2S Valid Range: 2 to 2.5S
6Ah	POUT_OP_WARN_LIMIT		R/W			Default: 1600W Valid Range: 1600 to 1920W
78h	STATUS_BYTE	-	R	1	Bitmapped	Returns the summary of critical faults.
	b7 - BUSY	-				Not supported.
	b6 - OFF	-				Unit is OFF.
	b5 - VOUT_OV	-				Output over-voltage fault has occurred.
	b4 - IOUT_OC	-				Output over-current fault has occurred.
	b3 - VIN_UV	-				An input under-voltage fault has occurred.
	b2 - TEMPERATURE	-				A temperature fault or warning has occurred.
	b1 - CML	-				A communication, memory or logic fault has occurred.
	b0 - NONE OF THE ABOVE	-				A fault warning not listed in bits[7:1] has occurred.



## PMBus™ SPECIFICATIONS

The DS1600SPE-3 Series Supported PMBus™ Command List:

Command Code	Command Name	Default Value	Access Type	Data Bytes	Data Format	Description
79h	STATUS_WORD	-	R	2	Bitmapped	Summary of units fault and warning status.
	b15 - VOUT					An output voltage fault or warning has occurred.
	b14 - IOUT/POUT					An output current or power fault or warning has occurred.
	b13 - INPUT					An input voltage, current or power fault or warning as occurred.
	b12 - MFR					A manufacturer specific fault or warning has occurred.
	b11 - POWER_GOOD#					The POWER_GOOD signal is de-asserted.
	b10 - FANS					A fan or airflow fault or warning has occurred.
	b9 - OTHER					Not supported
	b8 - UNKNOWN					Not supported
	b7 - BUSY					A fault was declared because the device was busy and unable to respond.
	b6 - OFF					Unit is OFF.
	b5 - VOUT_OV					Output over-voltage fault has occurred.
	b4 - IOUT_OC					Output over-current fault has occurred.
	b3 - VIN_UV					An input under-voltage fault has occurred.
	b2 - TEMPERATURE					A temperature fault or warning has occurred.
b1 - CML					A communication, memory or logic fault has occurred.	
b0 - NONE_OF_THE_ABOVE					A fault or warning not listed in bits[7:1] of this byte has occurred.	
7Ah	STATUS_VOUT	-	R/W	1	Bitmapped	Output voltage related faults and warnings
	b7					VOUT over-voltage fault
	b6					VOUT over-voltage warning
	b5					VOUT under-voltage warning
	b4					VOUT under-voltage fault
	b3					VOUT_MAX warning, an attempt has been made to set output to a value higher than the highest permissible voltage.
	b2					TON_MAX_FAULT
	b1					TOFF_MAX warning. Not supported.
b0					Not supported.	

## PMBus™ SPECIFICATIONS

The DS1600SPE-3 Series Supported PMBus™ Command List:

Command Code	Command Name	Default Value	Access Type	Data Bytes	Data Format	Description
7Bh	STATUS_IOUT	00	R/W	1	Bitmapped	Output current related faults and warnings.
	b7					IOUT Over Current Fault
	b6					IOUT Over Current and Low Voltage Shutdown Fault
	b5					IOUT Overcurrent Warning
	b4					IOUT Undercurrent Fault
	b3					Current Share Fault
	b2					Power Limiting
	b1					POUT Overpower Fault
	b0					POUT Overpower Warning
7Ch	STATUS_INPUT	-	R/W	1	Bitmapped	Input related faults and warnings.
	b7					VIN Overvoltage Fault
	b6					VIN Overvoltage Warning
	b5					VIN Under-voltage Warning
	b4					VIN Under-voltage Fault
	b3					Unit is OFF for insufficient input voltage.
	b2					IIN Over Current Fault
	b1					IIN over current warning
	b0					PIN overpower warning
7Dh	STATUS_TEMPERATURE	-	R/W	1	Bitmapped	Temperature related faults and warnings.
	b7					Over-temperature Fault
	b6					Over-temperature Warning
	b5					Under-temperature Warning.
	b4					Under-temperature Fault.
	b3:0					Reserved
7Eh	STATUS_CML	-	R/W	1	Bitmapped	Communications, logic and memory
	b7					Invalid or unsupported command received.
	b6					Invalid Data
	b5					Packet Error Check Failed
	b4					Memory Fault Detect, CRC Error
	b3					Not supported.
	b2					Not supported.
	b1					Not supported.
	b0					Not supported.

## PMBus™ SPECIFICATIONS

The DS1600SPE-3 Series Supported PMBus™ Command List:

Command Code	Command Name	Default Value	Access Type	Data Bytes	Data Format	Description
80h	STATUS_MFR_SPECIFIC	-	R/W	1	Bitmapped	Manufacturer Status Codes
	b7					Not Used
	b6					Not Used
	b5					Not Used
	b4					Not Used
	b3					Not Used
	b2					Not Used
	b1					Not Used
	b0					MFR SPECIFIC FAULT For trouble shooting.
81h	STATUS_FANS_1_2	00	R/W	1	Bitmapped	
	b7					Fan 1 fault
	b6					Fan 2 fault
	b5					Fan 1 warning
	b4					Fan 2 warning
	b3					Fan 1 speed overridden
	b2					Fan 2 speed overridden
	b1					Not used
	b0					Not used
86h	READ_EIN	-	BR	6	Direct	Returns the accumulated input power over time.
87h	READ_EOUT	-	BR	6	Direct	Returns the accumulated output power over time.
88h	READ_VIN	-	R	2	Linear	Returns input voltage in Volts ac.
89h	READ_IIN	-	R	2	Linear	Returns input current in Amperes.
8Ah	READ_VCAP	-	R	2	Linear	Not supported
8Bh	READ_VOUT	-	R	2	Linear	Returns the actual, measured voltage in Volts.
8Ch	READ_IOUT	-	R	2	Linear	Returns the output current in amperes.
8Dh	READ_TEMPERATURE_1	-	R	2	Linear	Primary side hotspot
8Eh	READ_TEMPERATURE_2	-	R	2	Linear	Secondary side hotspot
8Fh	READ_TEMPERATURE_3	-	R	2	Linear	Secondary side ambient
90h	READ_FAN_SPEED_1	-	R	2	Linear	Speed of fan 1
96h	READ_POUT	-	R	2	Linear	Returns the output power, in Watts.
97h	READ_PIN	-	R	2	Linear	Returns the input power, in Watts.
98h	PMBus™_REVISION	22	R	1	Bitmapped	Reads the PMBus™ revision number
	b7:5	0001				Part 1 Revision 0000 - Revision 1.0 0001 - Revision 1.1 0010 - Revision 1.2
	b4:0	0001				Part 2 Revision 0000 - Revision 1.0 0001 - Revision 1.1 0010 - Revision 1.2
99h	MFR_ID	"ARTESYN"	BR	7	ASCII	Abbrev or symbol of manufacturers name. ASCII (artesyn)

## PMBus™ SPECIFICATIONS

The DS1600SPE-3 Series Supported PMBus™ Command List:

Command Code	Command Name	Default Value	Access Type	Data Bytes	Data Format	Description
9Ah	MFR_MODEL	"DS1600SPE-3"	BR, ASCII	15	ASCII	Manufacturers Model Number, ASCII format
9Bh	MFR_REVISION	"AA"	BR, ASCII	2	ASCII	Manufacturers Revision Number, ASCII format
9Ch	MFR_LOCATION	"China"	BR, ASCII	Varies	ASCII	Manufacturers Facility, ASCII format
9Dh	MFR_DATE	"WW"	BR	6	ASCII	Manufacture Date, ASCII format structure: YYMMDD
9Eh	MFR_SERIAL	"K369WWSSSS AAZ"	BR	13	ASCII	Unit Serial Number, ASCII format.
A0h	MFR_VIN_MIN	EADO	R	2	Linear	Minimum Input Voltage (90Vac)
A1h	MFR_VIN_MAX	FA10	R	2	Linear	Maximum Input Voltage (264Vac)
A2h	MFR_IIN_MAX	D280	R	2	Linear	Maximum Input Current (10A)
A3h	MFR_PIN_MAX	-	R	2	Linear	Maximum Input Power (1780W)
A4h	MFR_VOUT_MIN	16CC	R	2	Linear	Minimum Output Voltage Regulation Window. (11.4V)
A5h	MFR_VOUT_MAX	1933	R	2	Linear	Maximum Output Voltage. Regulation Window (12.6V)
A6h	MFR_IOUT_MAX	-	R	2	Linear	Maximum Output Current (133.3A)
A7h	MFR_POUT_MAX	-	R	2	Linear	Maximum Output Power (1600W)
A8h	MFR_TAMBIENT_MAX	E320	R	2	Linear	Maximum Operating Ambient Temperature (Secondary Ambient) (50degC)
A9h	MFR_TAMBIENT_MIN	000A	R	2	Linear	Minimum Operating Ambient Temperature (Secondary Ambient) (0degC)
AAh	MFR_EFFICIENCY_LL		BR	14	Linear	Default: 115V, 160W, 89 %; 400W, 91.5%; 800W, 89%.
ABh	MFR_EFFICIENCY_HL		BR	14	Linear	Default: 230V, 320W, 93%; 800W, 94%, 1600W, 92%.
B0h	USER_DATA_00		BR/BW	Varies	Hex	
E0h	FW_PRI_VERSION		BR	8	ASCII	
E1h	FW_SEC_VERSION		BR	8	ASCII	
F0h	PMBUS_IMP_SPEC_REVISION	AC	BR	2	ASCII	
F1h	ISP_UNLOCK_CODE		BR/BW	4	ASCII	
F2h	ISP_CTRL_CMD		W	1	Bitmapped	
F3h	ISP_STATUS_BYTE		R	2	Bitmapped	
F4h	ISP_FLASH_ADDR		BR/BW	4	Hex	
F5h	ISP_FLASH_DATA.		BR/BW	4	Hex	

## APPLICATION NOTES

### Current Sharing

The DS1600SPE-3 series main output  $V_O$  is equipped with current sharing capability. This will allow up to 4 power supplies to be connected in parallel for higher power application. Current share accuracy is typically 5% of full load. When supplying light loads between 10% and 100% of its rated load, the power supplies will share within 5% accuracy. Below 10% total loading, there is no guarantee of output current sharing.

The current sharing has been tested with a distribution impedance of about 200 micro-ohm.

### Redundancy / Fault Tolerance

The DS1600SPE-3 series is able to current share with 2 (1+1) up to 4 (2+2) or 6 (3+3) power supplies in parallel and operate in a hot swap/redundant N+N configuration where N=1, 2, or 3. The 12V  $V_{SB}$  outputs of the power supplies are connected together in the system so that a failure or hot swap of a redundant power supply does not cause these outputs to go out of regulation in the system.

All power supply outputs will be designed for redundant mode operation. No internal failure in any power supply in this configuration should cause the bus voltage to fall below the regulation limits specified. All output voltages should stay within the regulation limits during cold swapping or hot swapping operation.

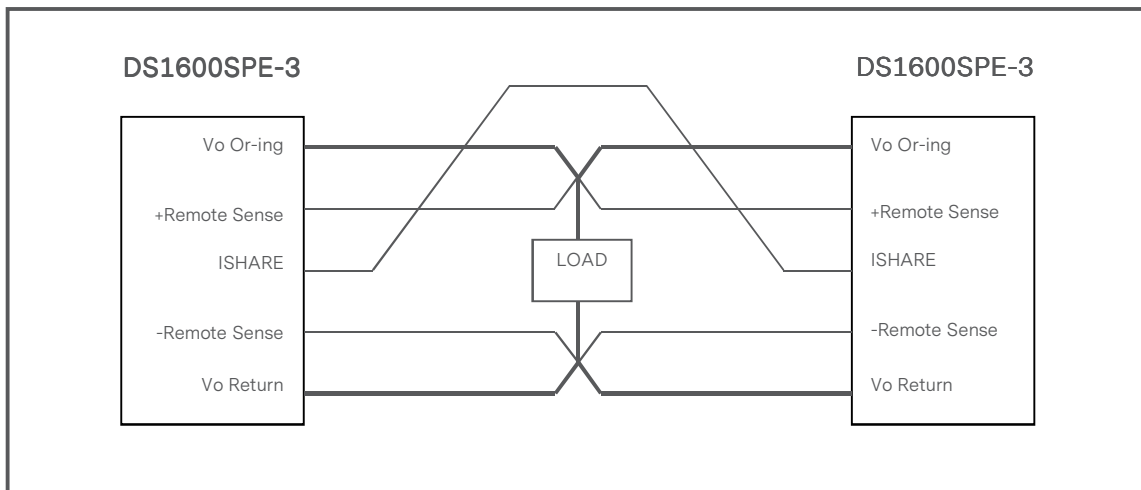

## APPLICATION NOTES

### Output Ripple and Noise Measurement

The setup outlined in the diagram below has been used for output voltage ripple and noise measurements on the DS1600SPE-3 series. When measuring output ripple and noise, a scope jack in parallel with a 0.1 $\mu$ F ceramic chip capacitor, and a 10 $\mu$ F tantalum capacitor will be used. Oscilloscope can be set to 20MHz bandwidth for this measurement.

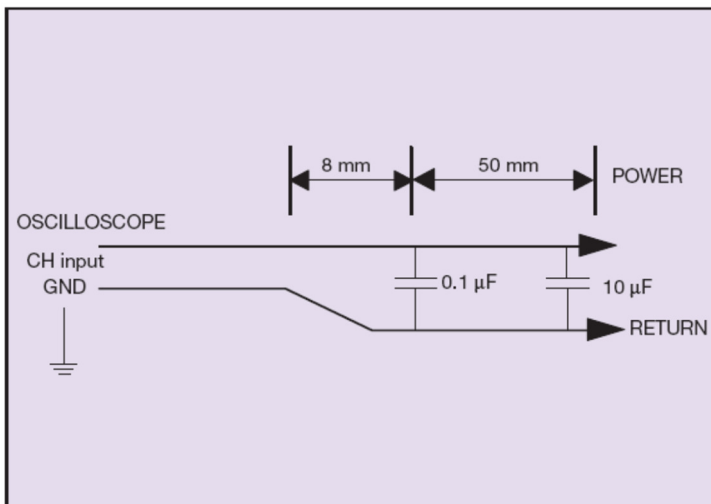

## RECORD OF REVISION AND CHANGES

Issue	Date	Description	Originators
1.0	08.17.2015	First issue	B. Wang
1.9	09.06.2015	Update PS_ON and PS_PRESENT description/update the command code 8Dh, 8Eh, 8Hh, description	B. Wang
2.0	03.22.2016	<ol style="list-style-type: none"> <li>1. Update dynamic test condition to maximum step size of 67A at 0.5A/<math>\mu</math>S, with a beginning load of 8A, and 3350<math>\mu</math>F capacitance.</li> <li>2. Update command list 40h from 1C33 to 1B99.</li> <li>3. Update the input voltage from 90-264Vac to 90-132Vac and 180-264Vac.</li> <li>4. Update input voltage from 90-132Vac to 90-140Vac.</li> <li>5. Add the AC line transient.</li> <li>6. Update the brown in/out.</li> <li>7. Add the standby mode operation to fan air cooling.</li> <li>8. Add a described standby output will shut down during fan latch/killed.</li> </ol>	B. Wang K. Wang
2.1	09.19.2016	Update DS1600SPE-3 FRU data 01h, 07h, 88h, 89h, D8h, D9h and FFh	B. Wang
2.2	02.02.2019	Update the command 01h	K. Wang
2.3	08.22.2019	Change control board resistors R410, R411 to 8.45Kohm main board resistors R4, R16 to 49.9Kohm	C. Liu
2.4	12.27.2019	Update current share description	K. Wang
2.5	05.27.2020	Update safety cert from 60950 to 62368-1	C. Liu
2.6	03.04.2021	Update cover and back cover	C. Liu
2.7	04.26.2022	Add UKCA Mark	C. Liu



For international contact information,  
visit [advancedenergy.com](http://advancedenergy.com).

[powersales@aei.com](mailto:powersales@aei.com) (Sales Support)  
[productsupport.ep@aei.com](mailto:productsupport.ep@aei.com) (Technical Support)  
+1 888 412 7832

## ABOUT ADVANCED ENERGY

Advanced Energy (AE) has devoted more than three decades to perfecting power for its global customers. AE designs and manufactures highly engineered, precision power conversion, measurement and control solutions for mission-critical applications and processes.

Our products enable customer innovation in complex applications for a wide range of industries including semiconductor equipment, industrial, manufacturing, telecommunications, data center computing, and medical. With deep applications know-how and responsive service and support across the globe, we build collaborative partnerships to meet rapid technological developments, propel growth for our customers, and innovate the future of power.

**PRECISION | POWER | PERFORMANCE**

---

Specifications are subject to change without notice. Not responsible for errors or omissions. ©2022 Advanced Energy Industries, Inc. All rights reserved. Advanced Energy®, and AE® are U.S. trademarks of Advanced Energy Industries, Inc.