

IMPAC IS 12 AND IGA 12

Robust pyrometers for non-contact temperature measurements on metals, ceramics, graphite, etc. between 250 and 3500°C (482 to 6332°F).



The Impac® IS 12, IS 12-S, IGA 12 and IGA 12-S are robust, digital and highly accurate pyrometers for non-contact temperature measurement on metals, ceramics, graphite, etc. For optimal match of the instrument to the application, six different fixed optics and three different focusable optics with extremely small spot sizes are available. The IS 12-S and IGA 12-S are equipped with an integrated scanner which moves the measuring beam adjustable up and down up to 4°.

PRODUCT HIGHLIGHTS

- Short response times < 1 ms
- Extremely small spot sizes min 0.1 mm
- Distance ratio up to 900 : 1
- Built-in 5 digit LED display
- Thru-lens view finder or with additional laser targeting light
- Test current output
- Two fast limit switches
- Interfaces RS232 / RS485 switchable
- With fixed or focusable optics

TYPICAL APPLICATIONS

- | | |
|--------------|---------------|
| ■ Preheating | ■ Sintering |
| ■ Annealing | ■ Melting |
| ■ Tempering | ■ Soldering |
| ■ Welding | ■ Rolling |
| ■ Forging | ■ Brazing |
| ■ Fardening | ■ Normalizing |

AT A GLANCE

Temperature Ranges

IS 12 and IS 12-S
550 to 2500°C (1022 to 4532°F)

IGA 12 and IGA 12-S
250 to 1400°C (482 to 2552°F)

Spectral Range

IS 12 and IS 12-S
0.7 to 1.1 µm

IGA 12 and IGA 12-S
1.45 to 1.8 µm

Measurement Uncertainty

< 1500°C: 0.3% oR + 1°C
> 1500°C: 0.5% oR

Repeatability

0.1% oR + 1°C

Optics

6 fixed optics
80 mm, 160 mm, 250 mm, 660 mm,
1300 mm, 5600 mm

3 focusable optics
277 to 533 mm, 388 to 1170 mm,
550 to 9500 mm

OVERVIEW

The pyrometer parameters can be selected via keys. The settings are indicated on the built-in LED display. In measuring mode, the actual temperature is indicated.

The pyrometers are equipped with RS232 and RS485 serial interfaces (switchable via the keys). This enables the reading of temperature and pyrometer parameters via the provided InfraWin PC-software. If necessary, the parameters also can be changed via PC.

Two adjustable limit switches can be used to trigger a switch process, e.g. to recognize hot objects located in the measuring beam.

A thru-lens view finder or laser targeting light for exact alignment of the pyrometer are available.

TECHNICAL DATA

Measurement Specifications		
Temperature Ranges	IS 12 and IS 12-S	550 to 1400°C (1022 to 2552°F) (MB 14)
		600 to 1600°C (1112 to 2912°F) (MB 16)
		650 to 1800°C (1202 to 3272°F) (MB 18)
		750 to 2500°C (1382 to 4532°F) (MB 25)
		550 to 2000°C (1022 to 3632°F) (MB 20L)
		700 to 3500°C (1292 to 6332°F) (MB 35L)
	IGA 12 and IGA 12-S	250 to 1000°C (482 to 1832°F) (MB 10)
		300 to 1300°C (572 to 2372°F) (MB 13)
		350 to 1800°C (662 to 3272°F) (MB 18)
		400 to 2300°C (752 to 4172°F) (MB 23)
		250 to 1400°C (482 to 2552°F) (MB 14L)
Sub Range	Any range adjustable within the temperature range, min span 50°C	
Spectral Range	IS 12 and IS 12-S: 0.7 to 1.1 µm	
	IGA 12 and IGA 12-S: 1.45 to 1.8 µm	
Resolution	Interface and display: 0.1°C	
	Analog output: < 0.025% of adjusted temperature range	
Amb. Temp. Dependency	$t_K \leq 0.01\%$ of reading (in °C) x dT (temperature of pyrometer housing: 23°C)	
Accuracy ($\epsilon = 1, t_{90} = 1 \text{ s}, T_{\text{amb}} = 23^\circ\text{C}$)	Below 1500°C: 0.3% of measured value in °C + 1°C	
	Above 1500°C: 0.5% of measured value in °C	
Repeatability ($\epsilon = 1, t_{90} = 1 \text{ s}, T_{\text{amb}} = 23^\circ\text{C}$)	0.1% of measured value in °C + 1°C	
Signal Processing	Photo current, digitized immediately	
Sighting	Built-in parallax free thru-lens view finder; or laser targeting light (max power level < 1 mW, $\lambda = 630$ to 680 nm, CDRH class II) Laser targeting (max power level < 1 mW, $\lambda = 630$ to 680 nm, CDRH class II)	

¹ MB is a shortcut used for temperature range (in German: Messbereich).

The determination of the technical data of this pyrometer is carried out in accordance with VDI/VDE IEC TS 62942-2, the calibration / adjustment in accordance with VDI/VDE 3511, Part 4.4.

TECHNICAL DATA (CONTINUED)

Electrical Specifications	
Power Supply	24 VDC (15 to 40 VDC) or 24 VAC (12 to 30 VAC), 48 to 62 Hz
Power Consumption	Max 7 W
Test Current Output	Fixed 10 mA
Isolation	Power supply, analog output, and digital interface are galvanically isolated against each other

Environmental Specifications	
Protection System	IP65 (according to DIN 40 050)
Ambient Temperature	0 to 70°C (32 to 158°F) at housing, non-condensing conditions
Storage Temperature	-20 to 70°C (-4 to 158°F)
Relative Humidity	Non-condensing conditions
Weight	2.2 kg (~2.20 lbs)
CE Label	According to EU directives about electromagnetic immunity

Interface Specifications	
Control Panel	4 keys, operate with tip of ball-point pen
Display	Built-in 5 digit LED display, additional function LEDs
Parameters	Adjustable at the instrument or via serial interface: emissivity ϵ , response time t_{90} , clear time for maximum value storage t_{CL} , subrange, 0 to 20 or 4 to 20 mA, switch points for limit switches, °C or °F, interface RS232 or RS485, address, baud rate, test current output
	Additionally adjustable (only via interface): keyboard lock, recalibration (with special software)

Communication Specifications	
Analog Output	Linear 0 to 20 mA or 4 to 20 mA, DC, switchable; load max 500 Ohm
Serial Interface	Switchable at the pyrometer: RS232 or RS485 addressable, half duplex; baud rate 2.4 up to 115 kBd
Limit Switches	2 relay outputs (change-over contacts), switch power max. 30 W (I_{max} : 1 A, U_{max} : 60 V DC)
Exposure Time t_{90}	< 1 ms ("L" temperature ranges with dynamic adaptation at low signal levels), adjustable up to 10 s
Maximum Value Storage	Single or double storage; cleared by: <ul style="list-style-type: none"> - Preselected time interval - External deletion contact or via digital interface - Automatically with the next measuring object

FEATURES

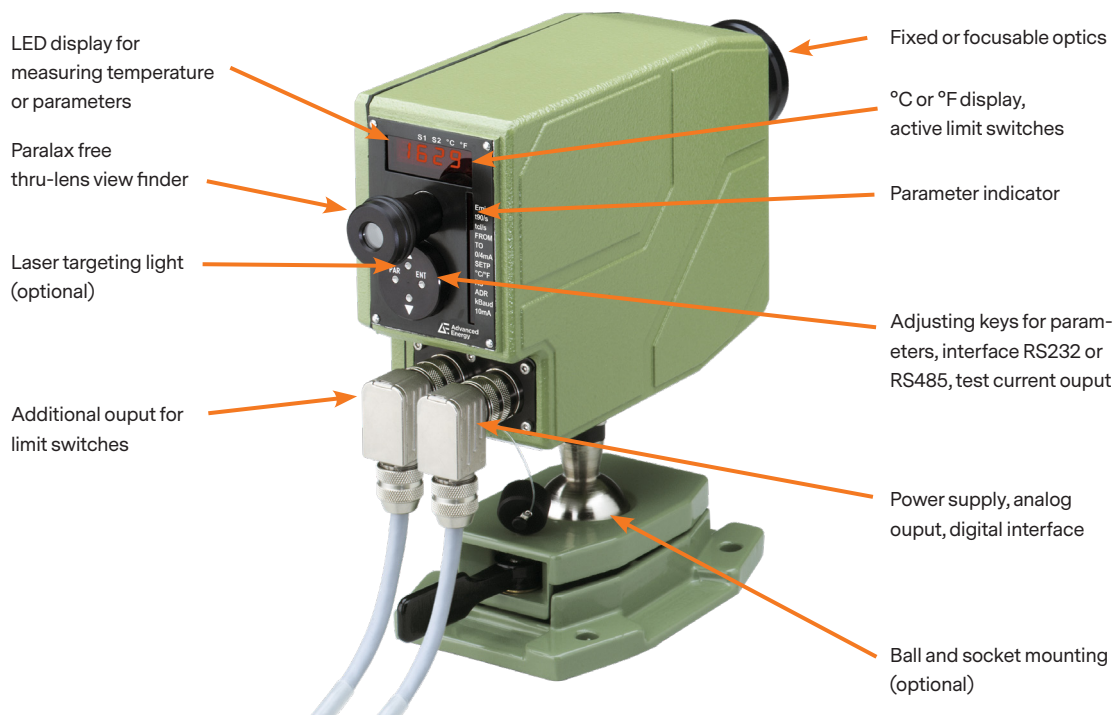

ADVANTAGES OF DIGITAL SIGNAL PROCESSING

The signal processing of Series 12 pyrometers is fully digital, i.e. the detector signal is digitized immediately and digitally processed. With this technique, extremely high accuracy, high repeatability, and very long measuring ranges are achieved.

Accuracy

The high accuracy will be achieved by the digital linearisation of the sensor output as well as the digital compensation of the ambient temperature.

Temperature Range

Due to the digital technique the user can set any temperature sub range within the full temperature range. The minimum span of the sub range is 51°C. The analog measuring output corresponds automatically to the selected sub range. This setting of a sub range can be done without recalibration of the pyrometer and does not affect the high accuracy and repeatability. As almost any sub range is adjustable, the storage of spare

instruments or the replacement of other pyrometers is simplified.

Output

The analog measuring outputs 0 to 20 mA or 4 to 20 mA are selectable as well as the serial digital interfaces RS232 or RS485. Additionally, the interface allows the controlling of the pyrometer via PC.

Bus Control

The serial interface RS485 facilitates the integration of the pyrometer into existing field bus systems.

Calibration

If a suitable calibration source is available, a calibration of the pyrometers can be done via serial interface without opening the housing.

DIMENSIONS

Types With Fixed Optics

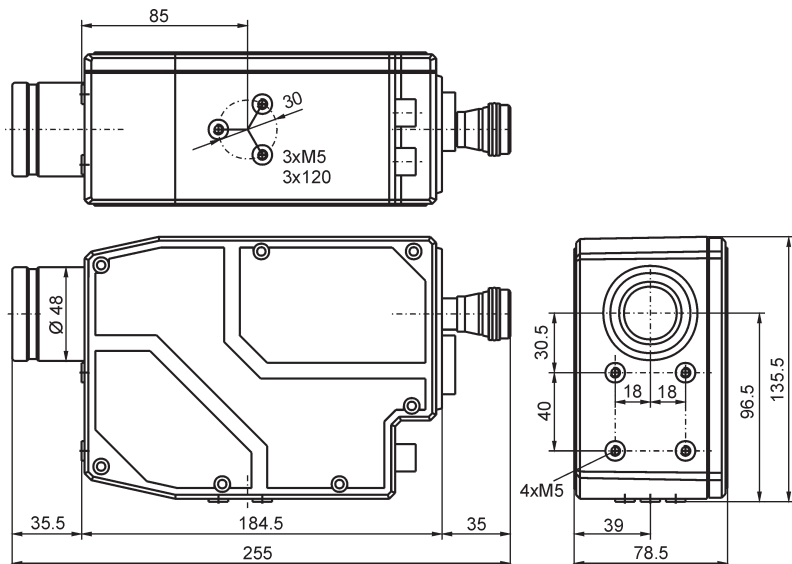

Types With Focusable Optics
(Optics Inserted/pulled Out)

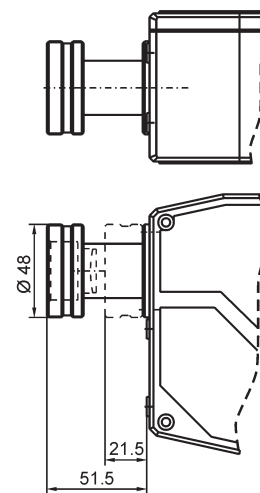

Dimensions in mm

IS 12-S AND IGA 12-S WITH INTEGRATED SCANNER

The pyrometers IS 12-S and IGA 12-S with fixed optics are equipped with a scanning mechanism built into the pyrometer housing which moves the measuring beam up and down. In combination with the pyrometer's maximum value storage (peak picker), the scanner is optimally used for scanning of thin oscillating wires, for finding scalefree spots on heavily scaled surfaces or for measuring small, hot objects whose position is not exactly determined.

All instruments are equipped with a thru-lens view finder and an additional laser targeting light for exact alignment to the position of the measuring object. The scanning angle is adjustable between 0 and 4° and the scanning frequency is between 4 and 10 Hz.

The moving measuring beam does not increase the spot sizes due to the very fast exposure time of the pyrometers. The scanning length increases with increasing measuring distance. An overview of the scanning length at the different distances of the optics is shown in the table.

Fixed Optics	
Measuring Distance a [mm]	Scanning Distance at 4° Scanning Angle
80	5.6 mm
160	11.2 mm
250	17.5 mm
660	46 mm
1300	91 mm
5600	391 mm

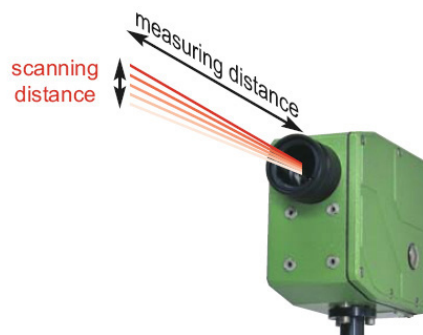

OPTICS

The pyrometers are equipped with fixed or focusable optics. Spot sizes for fixed optics are shown for the specified measuring distance. The focusable optics offer the smallest possible spot size at the required distance. The spot sizes are shown in the following tables (all distances are measured from the front of the lens).

For spot sizes between those in the table, values can be found by interpolation. The optics can be changed at any time to another of the same type without recalibrating the pyrometer. The focusable type is available for 6 different distance ranges. Each measuring distance can be adjusted within the mentioned limits to achieve the smallest spot size in the required distance.

The selection of a suitable optics depends on different factors:

- Very short measuring distances up to 250 mm to achieve extremely small spot sizes are only available as fixed optics.
- The rotary mirror attachment ROT 10 can only be used in combination with fixed optics.
- The 3 focusable optics allow the exact adjustment of any required measuring distance from 277 mm.
- Focusable optics offer high flexibility to adapt the instrument to applications with different measuring distances.

Fixed Optics IS 12, IS 12-S, IGA 12, IGA 12-S					
IS 12, IS 12-S		MB 14	-	MB 16, 18, 20L	MB 25, 35L
IGA 12, IGA 12-S		MB 10	MB 13, 14L	MB 18	MB 23
Optics	Measuring Distance a [mm]	Spot Size M ₉₀ [mm]			
1	80	0.9	0.7	0.3	0.1
2	160	0.7	0.6	0.4	0.2
3	250	1	0.8	0.5	0.3
4	660	2.3	2	1.2	0.7
5	1300	5.5	3.8	2.8	1.4
6	1500	19	15	12	6.4
Aperture D		19	13.5	10	7

Spot sizes differing from the stated values can be calculated with the following equations:

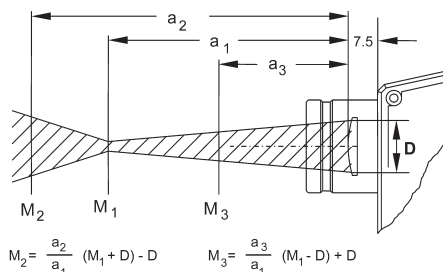

Focusable Optics IS 12					
Optics	Measuring Distance a [mm]	Spot Size M ₉₀ [mm]			
		MB 14	MB 16	MB 18 MB 20L	MB 25 MB 35L
1	277	0.9	0.6	0.6	0.4
	400	1	0.8	0.8	0.5
	533	1.4	1.1	1.1	0.7
2	388	1	0.8	0.8	0.45
	700	1.8	1.5	1.5	0.8
	1170	3	2.4	2.4	1.4
3	550	1.5	1	1	0.6
	3000	9	6	6	3.3
	9500	25	19	19	10.6
Aperture D ¹		13.5 to 17		10 to 13	5 to 7

Focusable Optics IGA 12					
Optics	Measuring Distance a [mm]	Spot Size M ₉₀ [mm]			
		MB 10	MB 13 MB 14L	MB 18	MB 23
1	279	1.3	0.9	0.5	0.4
	400	1.7	1.1	0.7	0.5
	520	2	1.2	0.8	0.7
2	390	1.4	1	0.6	0.45
	700	2.6	1.5	1	0.8
	1190	4.1	2.4	1.6	1.3
3	550	2	1.2	0.8	0.6
	3000	10.7	5.9	4.3	3.8
	5600	20	11	8	7
Aperture D ¹		13.5 to 17			10 to 13

¹ Dependent on the objective distance

ROTARY MIRROR ATTACHMENT ROT 10 (ACCESSORY)

For larger scanning distances than the integrated scanner, the rotary mirror attachment ROT 10 can be mounted on the IS 12 and IGA 12 with fixed optics. So a scanning angle between 63 and 73° can be achieved (depending on the measuring range).

Typical applications of the rotary mirror attachment are measurements of thin oscillating wires or moving sheets and capturing the maximum temperature of bulk material or scaled metals.

With help of a rotating mirror the measuring beam of the pyrometer is moved over the measuring object in a line. If the instrument is equipped with a laser targeting light, the scanning distance can be followed visually.

The rotary mirror attachment can only be mounted onto the fixed optics pyrometers. The distance of the pyrometer's lens to the window of the scanner is 106 mm. The required optic has to be selected accordingly.

The signal is analyzed via the pyrometer's analog output (0/4 to 20 mA) and / or the serial interface (RS232 or RS485).

The scanning frequency is permanently set to 12.5 Hz. The attachment is powered by 24 V AC, 50 Hz.

The pyrometer has to be adjusted to the fastest exposure time due to the mirror rotation, to keep the smallest spot size. The high mirror rotation speed of the mirror produces spot sizes in form of a line. For the different temperature ranges (MB), the following spot sizes are achieved:

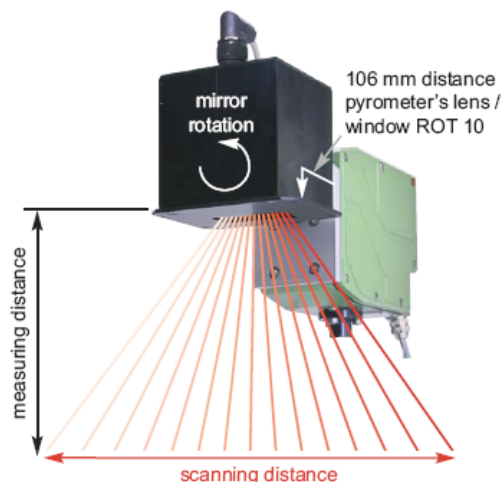

An overview of the scanning distances of the different measuring distances is shown in the following table:

Fixed Optics IS 12, IS 12-S, IGA 12, IGA 12-S		
Fixed Optics	Measuring Distance	Scanning Distance
2	54 mm	130 mm
3	144 mm	261 mm
4	554 mm	857 mm
5	1194 mm	1768 mm
6	5494 mm	8035 mm

Fixed Optics IS 12, IS 12-S, IGA 12, IGA 12-S					
IS 12, IS 12-S		MB 14	-	MB 16, 18, 20L	MB 25, 35L
IGA 12, IGA 12-S		MB 10	MB 13, 14L	MB 18	MB 23
Fixed Optics	Measuring Distance	Spot Size M ₉₀ [mm]			
2	54 mm	2.1 x 0.7	2.0 x 0.6	1.8 x 0.4	1.6 x 0.2
3	144 mm	4.8 x 1.0	4.6 x 0.8	4.3 x 0.5	4.1 x 0.3
4	554 mm	16.8 x 2.3	16.5 x 2.0	15.7 x 1.2	15.2 x 0.7
5	1194 mm	36.8 x 5.5	35.1 x 3.8	34.1 x 2.8	32.7 x 1.4
6	5494 mm	162.9 x 19.0	158.9 x 15	155.9 x 12.0	150.3 x 6.4
Scanning Angle		63°	68°	72°	73°

REFERENCE NUMBERS

IS 12 and IGA 12						
Type	Temperature Range	MB	With view finder, fixed optics	With view finder, fixed optics, laser targeting light	With view finder, focusable optics, laser targeting light]	With view finder, fixed optics, laser targeting light, scanner (type -S)
IS 12	500 to 1400°C	(MB 14)	3 839 100	3 839 110	3 839 120	3 839 130
	600 to 1600°C	(MB 16)	3 839 150	3 839 160	3 839 170	3 839 180
	650 to 1800°C	(MB 18)	3 839 200	3 839 210	3 839 220	3 839 230
	750 to 2500°C	(MB 25)	3 839 250	3 839 260	3 839 270	3 839 280
	550 to 2000°C	(MB 20L)	3 839 300	3 839 310	3 839 320	3 839 330
	700 to 3500°C	(MB 35L)	3 839 350	3 839 360	3 839 370	3 839 380
IGA 12	250 to 1000°C	(MB 10)	3 839 600	3 839 610	3 839 620	3 839 630
	300 to 1300°C	(MB 13)	3 839 650	3 839 660	3 839 670	3 839 680
	350 to 1800°C	(MB 18)	3 839 700	3 839 710	3 839 720	3 839 730
	400 to 2300°C	(MB 23)	3 839 750	3 839 760	3 839 770	3 839 780
	250 to 1400°C	(MB 14L)	3 839 800	3 839 810	3 839 820	3 839 830

Scope of Delivery

Pyrometer with optics of your selection, InfraWin operating and analyzing software, works certificate, user manual.

Ordering Note

When ordering, please select one optics (included in scope of delivery). A connection cable or an additional cable for limit contacts is not included in the scope of delivery.

ACCESSORIES

PN	Description
3 820 340	Connection cable, length 5 m, 90° connector
3 820 530	Connection cable, length 10 m, 90° connector
3 820 540	Connection cable, length 15 m, 90° connector
3 820 830	Connection cable, length 20 m, 90° connector
3 820 840	Connection cable, length 25 m, 90° connector
3 820 550	Connection cable, length 30 m, 90° connector
3 820 750	Connection cable, length 5 m, 90° connector, temperature resistant up to 200°C
3 821 120	Additional cable for limit contacts, 5 m
3 821 130	Additional cable for limit contacts, 10 m
3 821 140	Additional cable for limit contacts, 15 m
3 821 150	Additional cable for limit contacts, 20 m
3 821 160	Additional cable for limit contacts, 25 m
3 821 170	Additional cable for limit contacts, 30 m
3 821 200	Additional cable for limit contacts, 5 m, temperature resistant up to 200°C
3 852 290	Power supply NG DC for DIN rail mounting; 100 to 240 VAC ⇒ 24 VDC, 1 A
3 852 540	Power supply NG 0D 85 to 265 VAC ⇒ 24 VDC, 600 mA
3 852 550	Power supply NG 2D for DIN rail mounting; 85 to 265 VAC ⇒ 24 VDC, 600 mA with 2 settable limit switches
3 826 750	USB to RS485 adapter cable, HS-version, 1.8 m long
3 852 580	Converter USB 2.0 ⇔ RS232
3 852 440	Protocol transducer RS485/RS232 (switch.) ⇔ Profibus-DP for 1 device
3 852 460	Protocol transducer RS485 ⇔ Profibus DP for 32 devices
3 852 620	Protocol converter UPP RS485 or RS232 ⇔ ProfiNet, for 1 pyrometer
3 852 630	Protocol converter UPP RS485 ⇔ ProfiNet, for max. 32 pyrometers
3 891 220	DA 4000: LED-display, 2-wire power supply, 2 limit switches (relay contacts), 115 VAC
3 890 650	DA 4000: LED-display, 2-wire power supply, 2 limit switches (relay contacts), 230 VAC
3 890 560	DA 6000-N: LED digital display with digital input RS232 and possibility for pyrometer parameter settings
3 890 570	DA 6000-N digital display, to allow adjustment of pyrometer through RS485 interface
3 890 520	DA 6000: LED digital display, digital and analog input, 2 limit switches, maximum value storage, analog output, RS232
3 890 530	DA 6000: like the DA 6000-N, but with analog input and 2 limit switches for the RS485 interface.
3 826 510	PI 6000: PID programmable controller, extremely fast, for digital Impac pyrometers
3 835 060	Air purge
3 837 200	Cooling plate
3 837 330	Cooling jacket
3 834 200	Ball and socket mounting
3 834 140	Ball and socket mounting (steel) for rough ambience or for cooling jacket
3 834 320	Mounting angle for Series 12
3 835 590	90° mirror for IS 12 & IGA 12 (for fixed optics only)
3 843 260	Rotary mirror attachment ROT 10
3 848 610	Exchangeable fixed optics 1
3 848 620	Exchangeable fixed optics 2
3 848 630	Exchangeable fixed optics 3

ACCESSORIES (CONTINUED)

PN	Description
3 848 640	Exchangeable fixed optics 4
3 848 650	Exchangeable fixed optics 5
3 848 660	Exchangeable fixed optics 6
3 848 670	Exchangeable focusable optics 1
3 848 680	Exchangeable focusable optics 2
3 848 690	Exchangeable focusable optics 3



Cooling jacket

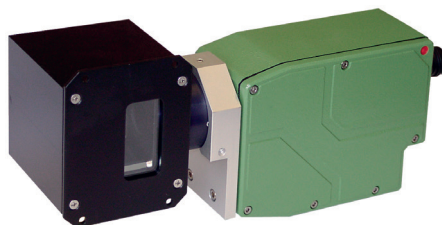

Rotary mirror attachment
ROT 10



NG DC



Ball and socket
mounting, steel



Ball and socket
mounting



LED digital display



Cooling plate



Air purge unit

INFRAWIN 5 OVERVIEW

InfraWin is easy-to-use measurement and evaluation software for remote configuration of stationary, digital Impac brand pyrometers.

This software allows the user to remotely adjust and control settings for one or two pyrometers from a single computer. InfraWin also allows the user to simultaneously monitor and control temperatures.

- Display temperature data as color bars and online graphics
- Capture downstream evaluations as tables, graphics or text files
- Calculate the spot size for different measuring distances
- Features UPP standard (Universal Pyrometer Protocol)

Pyrometer Settings

An Impac digital pyrometer connected to a PC will be automatically detected by the software. All available parameters are adjustable, including emissivity, response time, maximum value storage, output signal and sub range.

Further special functions are adjustable for example controllers or TV parameters on instruments available with these functions. Changes are transmitted directly to the pyrometer.



Measurement with Internal Temperature of radiation temperature and internal instrument temperature. Parameters can be changed during the measurement.

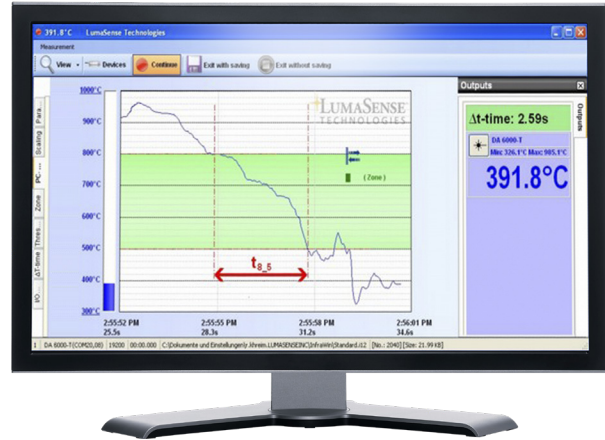

Measurement with Color Bar

In this window a temperature value for the upper or lower limit can be adjusted numerically or with the mouse. The acquired minimum and maximum value is indicated as well as the inner temperature of the pyrometer. The emissivity is changeable during the measurement at any time.

Infrared Calculator

After input of the aperture and the focused spot size per datasheet, the calculation of spot sizes at non-focused distances is possible.

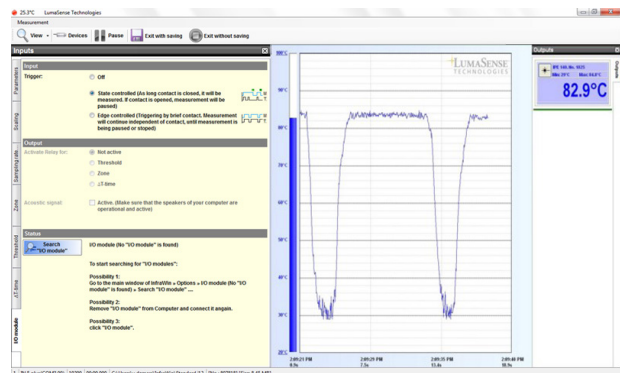

I/O Module allows users to trigger measurement externally and gives a potential free output contact.

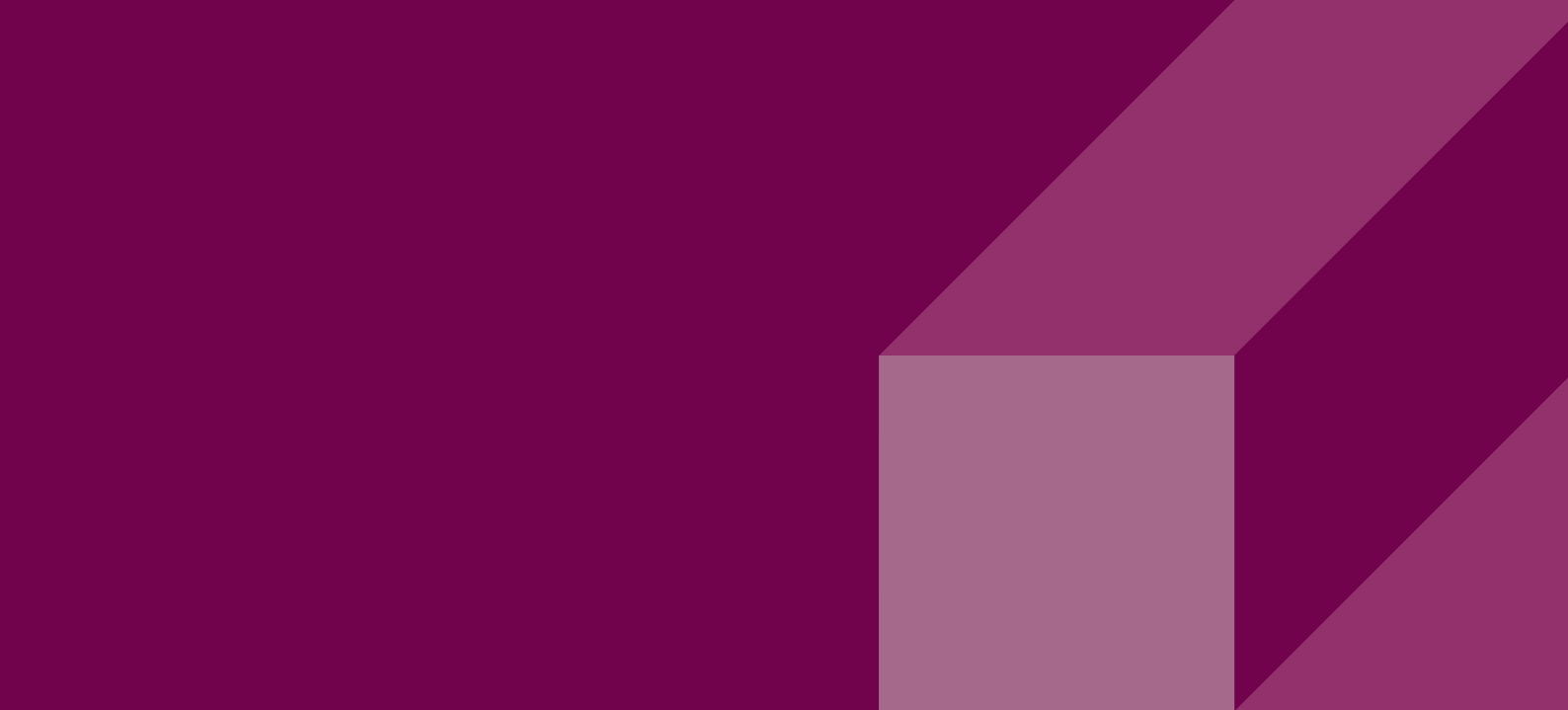

ABOUT ADVANCED ENERGY

Advanced Energy (AE) has devoted more than three decades to perfecting power for its global customers. AE designs and manufactures highly engineered, precision power conversion, measurement and control solutions for mission-critical applications and processes.

AE's power solutions enable customer innovation in complex semiconductor and industrial thin film plasma manufacturing processes, demanding high and low voltage applications, and temperature-critical thermal processes.

With deep applications know-how and responsive service and support across the globe, AE builds collaborative partnerships to meet rapid technological developments, propel growth for its customers and power the future of technology.

PRECISION | POWER | PERFORMANCE

For international contact information,
visit advancedenergy.com.

sales.support@aei.com
+1 970 221 0108

Specifications are subject to change without notice. Not responsible for errors or omissions. ©2019 Advanced Energy Industries, Inc. All rights reserved. Advanced Energy®, Impac®, and AE® are U.S. trademarks of Advanced Energy Industries, Inc.

